

V&V Valli&Valli

ASSA ABLOY

Collezione Valli&Valli
Valli&Valli Collection



Indice generale

General index



ASSA ABLOY

Sistemi di fissaggio / Fixing versions available	Pag	4
Maniglie / Door handles	Pag	6
Coordinati / Coordinated accessories	Pag	109
Pomoli / Doorknobs	Pag	109
Maniglioni / Pull handles	Pag	116
Maniglie per incasso / Inset handles	Pag	121
Fermaporta / Door stops	Pag	129
Portabiti / Ganci - Coathooks / Hooks	Pag	130
Maniglie per Mobile / Furniture fittings	Pag	133
Pomoli per mobili / Furniture knobs	Pag	143
Cerniere per mobili / Furniture hinges	Pag	145

Indice analitico *Index*

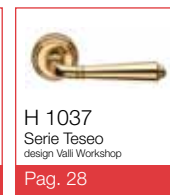
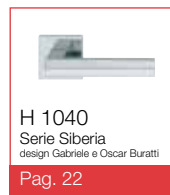
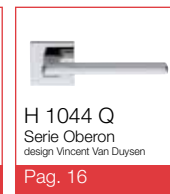

2

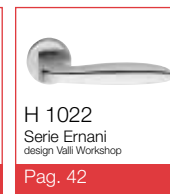

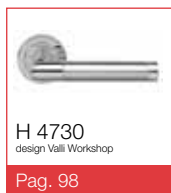
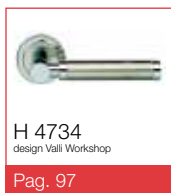
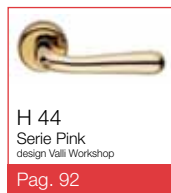
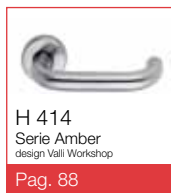
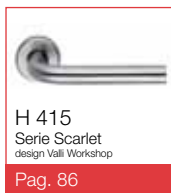

Vari sistemi di fissaggio

Fixing versions available



4

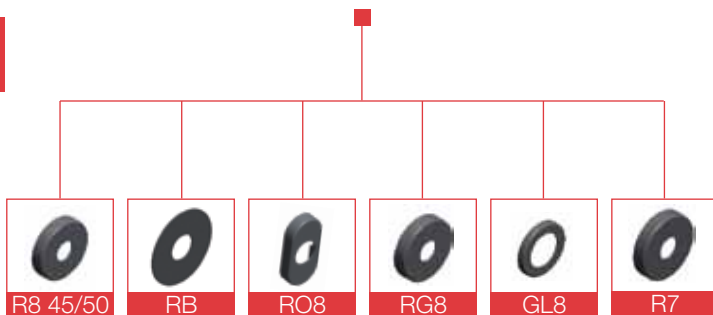

Molla
Spring R8 45/50

R8 45/50 - Rosetta da 45 e 50 (□ 8)
R8 45/50 - Anchor rose with wooden screws (8 mm spindle)



RB - Rosetta bassa da 50 (□ 8)
RB - Flat rose (8 mm spindle)



RO8 - Rosetta stretta (□ 8)

RO8 - Narrow anchor rose with wooden screws (8 mm spindle)



GL8 - Rosetta porte vetro (□ 8)

GL8 - Anchor rose for glass doors (8 mm spindle)



RG8 - Rosetta da 50 e sottocostruzioni con viti passanti (□ 8 / □ 8,5)

RG8 - Anchor rose for bolt through fixing (8/8.5 mm spindle)



R7 - Rosetta da 50 (□ 7)

R7 - Anchor rose with wooden screws (7 mm spindle)

H 1050

Serie Giasone

design Valli Workshop

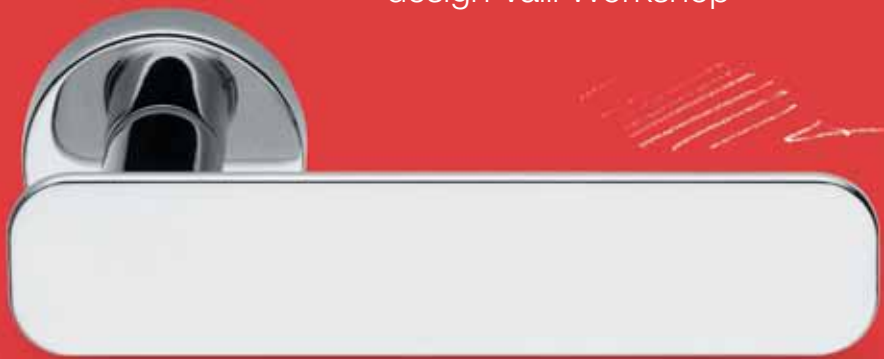

H 1050 Serie Giasone

design Valli Workshop

Valli&Valli

ASSA ABLOY

Materiale Ottone

Material Brass

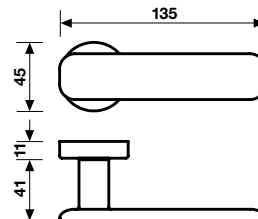

Finiture

Finishes

Maniglia per finestra

Window Handle

Nella stessa serie sono disponibili

Coordinated accessories

7



H 1050 FRS-41



K 1168

Pomolo per porta

Door knob _____ pag. 109

H 1049

Serie Divara

design Valli Workshop



8



H 1049 Serie Divara

design Valli Workshop

Valli&Valli

ASSA ABLOY

Materiale Ottone

Material Brass

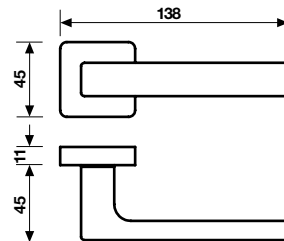

Finiture

Finishes

Maniglia per finestra

Window Handle

9



H 1049 FRS-41



H 1046

Serie Nais

design Valli Workshop



10



H 1046 Serie Nais

design Valli Workshop

Valli&Valli

ASSA ABLOY

Materiale Ottone

Material Brass



H 1046 R8

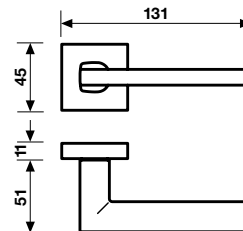

Finiture

Finishes

Maniglia per finestra

Window Handle

11



Cromo



Cromsatin

H 1046 F



H 1046 FRS-41



Certificato secondo ÖNORM B 3859
Maniglie per porte antincendio
Certified in compliance with ÖNORM B 3859
Leverhandles for fire resisting doors

H 1045

Serie Bess

design Yoshimi Kono



12



H 1045 Serie Bess

design Yoshimi Kono

Valli&Valli

ASSA ABLOY

Materiale Nikrall Lega Zama UNI 3717

Material Nikrall Lega Zama UNI 3717



H 1045 R8

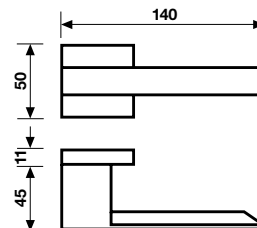

Finiture

Finishes



Cromo



Cromsatin



Cromsatin/Cromo

Maniglia per finestra

Window Handle

H 1045 F



H 1045 FRS-41



Nella stessa serie sono disponibili

Coordinated accessories

K 1165

Pomolo per porta

Door knob _____ pag. 110

K 1228

Maniglione

Pull handle _____ pag. 116

K 169

Maniglione

Pull handle _____ pag. 119

K 1232

Maniglia per incasso

Inset handles _____ pag. 121

K 1230

Maniglia per incasso

Inset handles _____ pag. 121

H 1044

Serie Oberon

design Vincent Van Duysen



14

H 1044 Serie Oberon

design Vincent Van Duysen

Valli&Valli

ASSA ABLOY

Materiale Nikrall Lega Zama UNI 3717

Material Nikrall Lega Zama UNI 3717

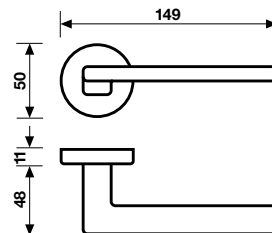

Finiture

Finishes

Maniglia per finestra

Window Handle

15



H 1044 F



H 1044 FRS-41



H 1044 Q

Serie Oberon

design Vincent Van Duysen



16



H 1044 Q Serie Oberon

design Vincent Van Duysen

Valli&Valli

ASSA ABLOY

Materiale Nikrall Lega Zama UNI 3717

Material Nikrall Lega Zama UNI 3717

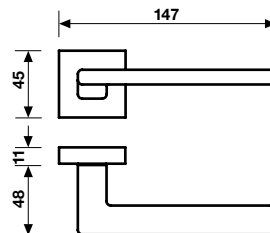

Finiture

Finishes

Maniglia per finestra

Window Handle

17



H 1044 F Q



H 1044 FRS-Q-41



H 1043

Serie Alcina

design Matteo Thun



18



H 1043 Serie Alcina

design Matteo Thun

Materiale Nikrall Lega Zama UNI 3717

Material Nikrall Lega Zama UNI 3717



H 1043 R8

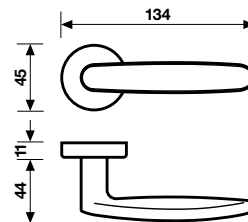

Finiture

Finishes

Maniglia per finestra

Window Handle

19



Orolux/Orsatin



Cromo/Cromsatin

H 1043 F



H 1043 FRS-41



H 1042

Serie Walkiria

design Panacom Architects Arseniy Leonovich



20

H 1042 Serie Walkiria

design Panacom Architects Arseniy Leonovich

Materiale Ottone
Material Brass



H 1042 R8

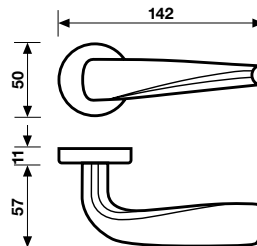

Finiture *Finishes*



Oro lucido



Cromo



Cromsatin

Maniglia per finestra *Window Handle*

H 1042 F



H 1042 FRS-41



Certificato secondo ÖNORM B 3859
Maniglie per porte antincendio
Certified in compliance with ÖNORM B 3859
Leverhandles for fire resisting doors

H 1040

Serie Siberia

design Gabriele e Oscar Buratti



22



H 1040 Serie Siberia

design Gabriele e Oscar Buratti

Valli&Valli

ASSA ABLOY

Materiale Ottone

Material Brass

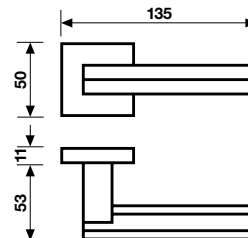

Finiture

Finishes

Maniglia per finestra

Window Handle

23



H 1040 F



H 1040 FRS-41



H 1039

Serie Fedra

design Jean-Baptiste Sibertin Blanc



24

H 1039 Serie Fedra

design Jean-Baptiste Sibertin Blanc

Materiale Ottone
Material Brass



H 1039 R8

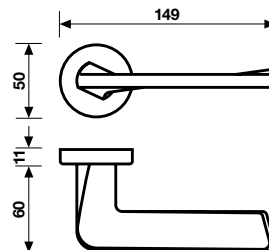

Finiture
Finishes



Oro lucido



Cromsatin/Cromo

Maniglia per finestra
Window Handle

H 1039 F



H 1039 FRS-41



H 1038

Serie Armida

design Decoma Design

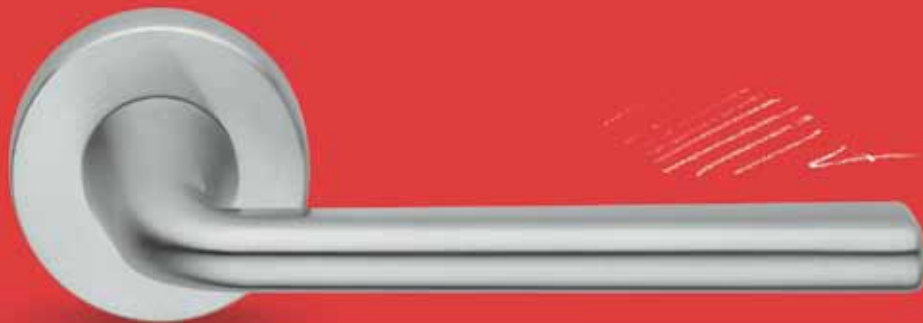

26



H 1038 Serie Armida

design Decoma Design

Materiale Nikrall Lega Zama UNI 3717

Material Nikrall Lega Zama UNI 3717

Valli&Valli

ASSA ABLOY

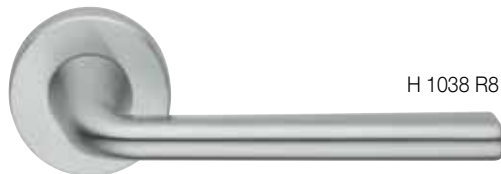

H 1038 R8

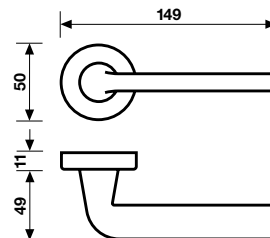

Finiture

Finishes

Maniglia per finestra

Window Handle

27



Orolux/Orsatin

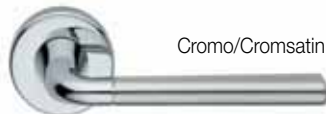

Cromo/Cromsatin



Cromsatin

H 1038 F



H 1038 FRS-41



H 1037

Serie Teseo

design Valli Workshop



28



H 1037 Serie Teseo

design Valli Workshop

Valli&Valli

ASSA ABLOY

Materiale Ottone

Material Brass



H 1037 R8

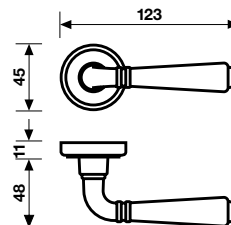

Finiture

Finishes

Maniglia per finestra

Window Handle

29



Oro lucido



Ottone naturale antico



Brunito

H 1037 F



H 1037 FRS-41



H 123

Serie Luigi XVI

design Valli Workshop



30

H 123 Serie Luigi XVI

design Valli Workshop

Valli&Valli

ASSA ABLOY

Materiale Ottone

Material Brass



H 123 R8

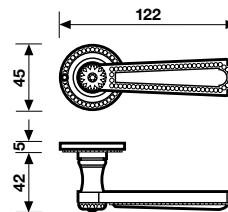

Finiture

Finishes

Maniglia per finestra

Window Handle

Nella stessa serie sono disponibili

Coordinated accessories

31



Oro lucido

H 123 FRS-41



Ottone naturale antico

K 121

Pomolo per porta

Door knob _____ pag. 113

H 120

Serie Luigi XV

design Valli Workshop



32



H 120 Serie Luigi XV

design Valli Workshop

Valli&Valli

ASSA ABLOY

Materiale Ottone

Material Brass



H 120 R8

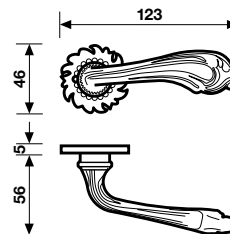

Finiture

Finishes

Maniglia per finestra

Window Handle

Nella stessa serie sono disponibili

Coordinated accessories

33



Oro lucido

H 120 FRS-41



Ottone naturale antico

K 120

Pomolo per porta

Door knob _____ pag. 114

H 1034

Serie Polis

design Decoma Design



34

H 1034 Serie Polis

design Decoma Design

Materiale Nikrall Lega Zama UNI 3717

Material Nikrall Lega Zama UNI 3717



H 1034 R8

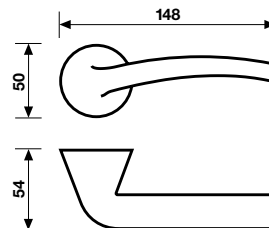

Finiture

Finishes

Maniglia per finestra

Window Handle

35



Cromo



Cromsatin

H 1034 F



H 1034 FRS-41



H 1027

Serie Dafne

design Studio Carlesi Design



36

H 1027 Serie Dafne

design Studio Carlesi Design

Valli&Valli

ASSA ABLOY

Materiale Ottone

Material Brass



H 1027 R8

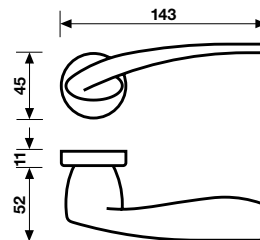

Finiture

Finishes

Maniglia per finestra

Window Handle

Oro lucido



Cromsatin



H 1027 FRS-41



H 1026

Serie Dido

design Antonio Bullo

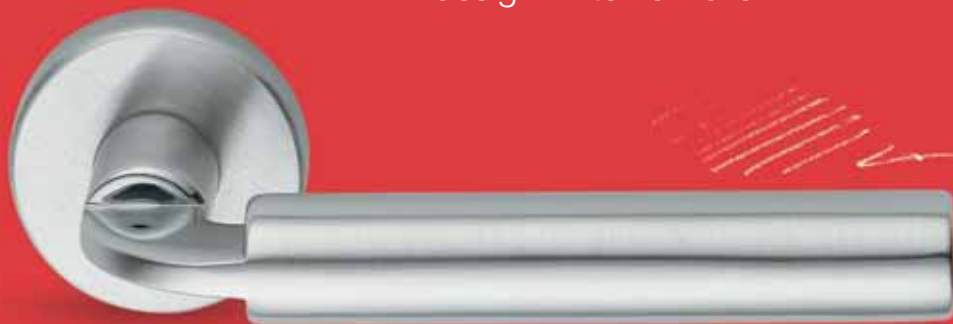

38

H 1026 Serie Dido

design Antonio Bullo

Materiale Ottone
Material Brass

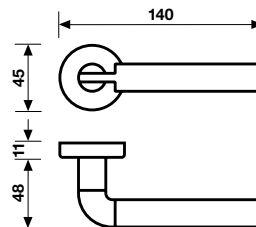

Finiture
Finishes

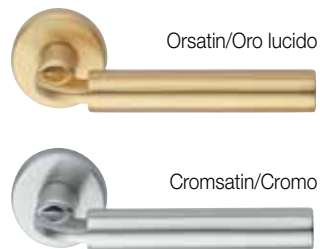

Maniglia per finestra
Window Handle

H 1026 F



H 1026 FRS-41



H 1024

Serie Lolita

design Valli Workshop



40



H 1024 Serie Lolita

design Valli Workshop

Valli&Valli

ASSA ABLOY

Materiale Ottone

Material Brass



H 1024 R8

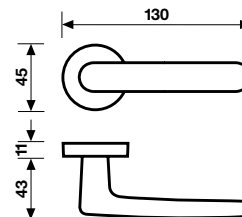

Finiture

Finishes

Maniglia per finestra

Window Handle

41



Oro lucido



Cromo



Cromsatin

H 1024 F

H 1024 FRS-41



Certificato secondo ÖNORM B 3859
Maniglie per porte antincendio
Certified in compliance with ÖNORM B 3859
Leverhandles for fire resisting doors

H 1022

Serie Ernani

design Valli Workshop



42



H 1022 Serie Ernani

design Valli Workshop

Valli&Valli

ASSA ABLOY

Materiale Ottone

Material Brass



H 1022 R8

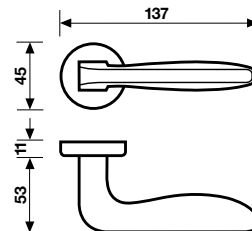

Finiture

Finishes

Maniglia per finestra

Window Handle

43



Oro lucido/Orsatin



Cromsatin/Cromo

H 1022 F



H 1022 FRS-41



H 1018

Serie Otello

design Marius Schreyer Design



44



H 1018 Serie Otello

design Marius Schreyer Design

Valli&Valli

ASSA ABLOY

Materiale Ottone

Material Brass



H 1018 R8

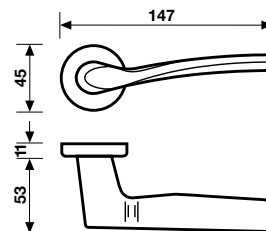

Finiture

Finishes

Maniglia per finestra

Window Handle

45



Oro lucido/Orsatin



Cromsatin/Cromo

H 1018 FRS-41



H 1017

Serie Camelia

design Matteo Thun



46



H 1017 Serie Camelia

design Matteo Thun

Valli&Valli

ASSA ABLOY

Materiale Ottone

Material Brass



H 1017 R8

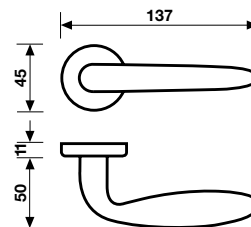

Finiture

Finishes

Maniglia per finestra

Window Handle

47



Oro lucido



Cromsatin

H 1017 F



H 1017 FRS-41



H 1016

Serie Nabucco

design Valli Workshop



48

H 1016 Serie Nabucco

design Valli Workshop

Materiale Ottone
Material Brass



H 1016 R8

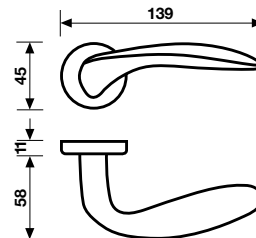

Finiture
Finishes



Oro lucido



Cromsatin



Anticato

Maniglia per finestra
Window Handle

H 1016 FRS-41



H 1015

Serie West

design Itamar Harari



50

H 1015 Serie West

design Itamar Harari

Valli&Valli

ASSA ABLOY

Materiale Ottone

Material Brass

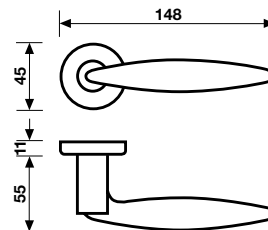

Finiture

Finishes

Maniglia per finestra

Window Handle

51

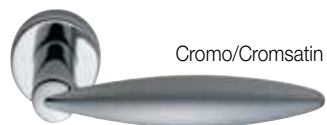

H 1015 FRS-41



H 1013

Serie Mosè

design Valli Workshop



52



H 1013 Serie Mosè

design Valli Workshop

Valli&Valli

ASSA ABLOY

Materiale Ottone

Material Brass



H 1013 R8

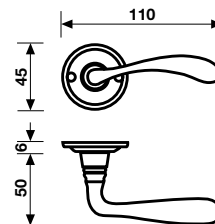

Finiture

Finishes

Maniglia per finestra

Window Handle

53



Ottone naturale



Brunito

H 1013 F



H 1013 FRS-41



H 1012

Serie Poliuto

design Valli Workshop



54



H 1012 Serie Poliuto

design Valli Workshop



ASSA ABLOY

Materiale Ottone
Material Brass



H 1012 R8

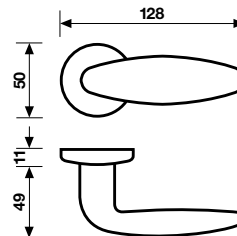

Finiture
Finishes

Maniglia per finestra
Window Handle

55



Oro lucido



Cromsatin

H 1012 F



H 1012 FRS-41



Certificato secondo ÖNORM B 3859
Maniglie per porte antincendio
*Certified in compliance with ÖNORM B 3859
Leverhandles for fire resisting doors*

H 1004

Serie Antares

design Valli Workshop



56



H 1004 Serie Antares

design Valli Workshop

Valli&Valli

ASSA ABLOY

Materiale Ottone / Ottone e Porcellana*

*Material Brass / Brass and Porcelain**



H 1004 R8

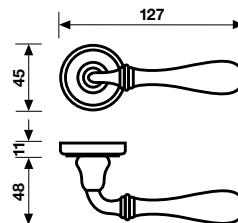

Finiture

Finishes



Oro lucido



Brunito/Avorio*



Ottone naturale



Fumè



Brunito

Maniglia per finestra

Window Handle

57

H 1004 F



H 1004 FRS-41



H 1004 P8



Finiture
Finishes

Oro lucido
Brunito

H 1003

Serie Croco

design Matteo Thun

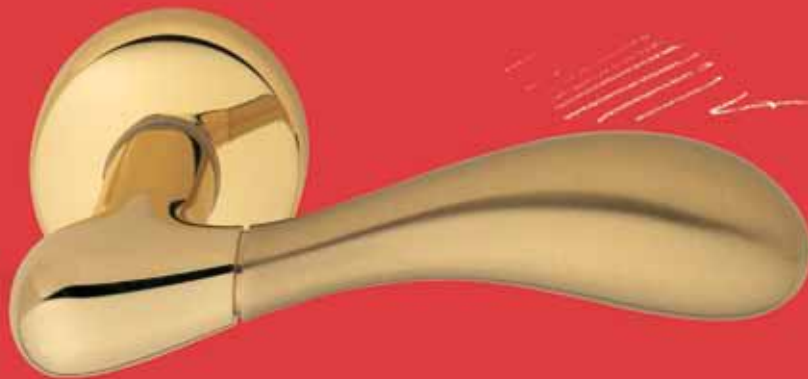

58

H 1003 Serie Croco

design Matteo Thun

Valli&Valli

ASSA ABLOY

Materiale Ottone

Material Brass



H 1003 R8

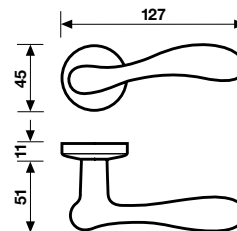

Finiture

Finishes

Maniglia per finestra

Window Handle

59



Oro lucido



Cromo/Cromsatin

H 1003 F



H 1003 FRS-41



Oro lucido/Orsatin



Cromsatin



Orsatin



Anticato

H 914/8

Serie Medicea

design Pasquale Valli



60



H 914/8 Serie Medicea

design Pasquale Valli

Materiale Ottone
Material Brass



H 915/8

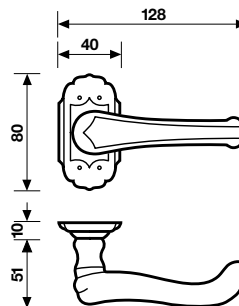

Valli&Valli
ASSA ABLOY

Finiture
Finishes



Patiné

Maniglia per finestra
Window Handle

H 916 F



H 914 FRS-41



H 914/8



H 198

Serie Mizar

design Eero Aarnio



62

H 198 Serie Mizar

design Eero Aarnio

Valli&Valli

ASSA ABLOY

Materiale Ottone
Material Brass



H 198 R8

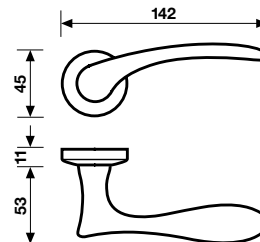

Finiture *Finishes*



Oro lucido

Orsatin

Cromsatin

Anticato

Maniglia per finestra *Window Handle*

H 198 F

H 198 FRS-41

H 198 P



Nella stessa serie sono disponibili *Coordinated accessories*

K 1210

Maniglione

Pull handle _____ pag. 118

Finiture *Finishes*

Oro lucido
Anticato

H 195

Serie Orchidea

design Valli Workshop



64

H 195 Serie Orchidea

design Valli Workshop

Valli & Valli

ASSA ABLOY

Materiale Ottone

Material Brass



H 195 R8

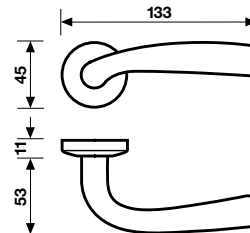

Finiture

Finishes

Maniglia per finestra

Window Handle

65



Oro lucido

H 195 F



Cromsatin

H 195 FRS-41



Certificato secondo ÖNORM B 3859
Maniglie per porte antincendio
Certified in compliance with ÖNORM B 3859
Leverhandles for fire resisting doors

H 192

Serie Prunus

design Valli Workshop

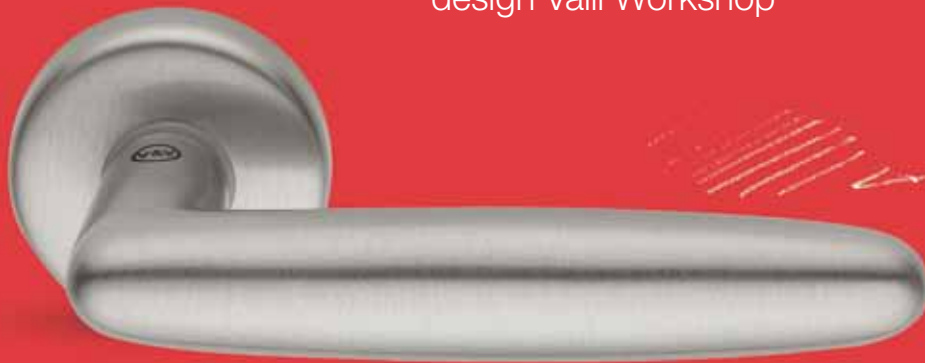

66



H 192 Serie Prunus

design Valli Workshop



ASSA ABLOY

Materiale Ottone

Material Brass



H 192 R8

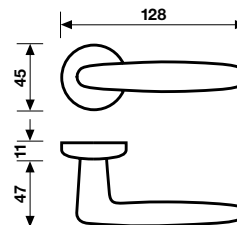

Finiture

Finishes

Maniglia per finestra

Window Handle

67



Nikmatt

H 192 F



H 192 FRS-41



Certificato secondo ÖNORM B 3859
Maniglie per porte antincendio
Certified in compliance with ÖNORM B 3859
Leverhandles for fire resisting doors

H 179

Serie Aida

design Matteo Thun



68



H 179 Serie Aida

design Matteo Thun

Materiale Ottone

Material Brass



H 179 R8

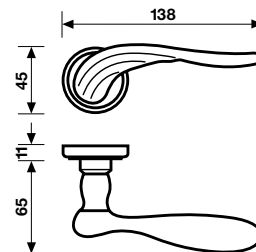

Finiture

Finishes

Maniglia per finestra

Window Handle

69



Oro lucido

H 179 F



H 179 FRS-41



H 176

Serie Spiga

design Valli Workshop



70



H 176 Serie Spiga

design Valli Workshop

Materiale Ottone e Porcellana

Material Brass and Porcelain

Valli&Valli

ASSA ABLOY



H 176 R8

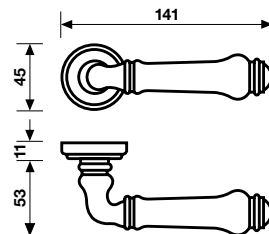

Finiture

Finishes

Maniglia per finestra

Window Handle

71



Bianco/Oro lucido



Fiorato/Oro lucido



Brunito/Avorio

H 176 F



H 176 FRS-41



H 174

Serie Altair

design Valli Workshop



72



H 174 Serie Altair

design Valli Workshop

Materiale Ottone
Material Brass



H 174 R8

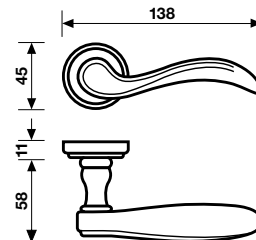

Finiture
Finishes



Oro lucido

Maniglia per finestra
Window Handle

H 174 F



H 174 FRS-41



Certificato secondo ÖNORM B 3859
Maniglie per porte antincendio
*Certified in compliance with ÖNORM B 3859
Leverhandles for fire resisting doors*

H 165

Serie Germana

design Valli Workshop



74

H 165 Serie Germana

design Valli Workshop

Valli&Valli

ASSA ABLOY

Materiale Ottone

Material Brass



H 165 R8

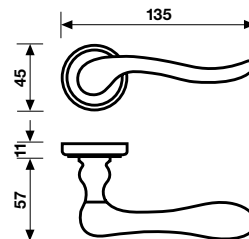

Finiture

Finishes

Maniglia per finestra

Window Handle

75



Oro lucido



Orsatin



Anticato

H 165 F



H 165 FRS-41



H 165 P



Finiture
Finishes

Oro lucido
Anticato

H 163

Serie Sarissa

design Valli Workshop



76



H 163 Serie Sarissa

design Valli Workshop



Materiale Ottone
Material Brass



H 163 R8

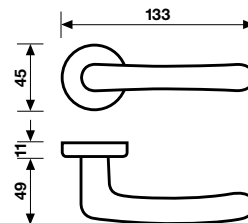

Finiture *Finishes*



Oro lucido



Cromsatin



Cromo

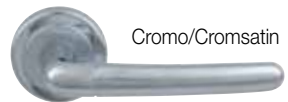

Cromo/Cromsatin

Finitura cromo/cromsatin disponibile in materiale Nikral Legra Zama Uni 3717 con sottorosetta con perni per viti passanti

Finish cromo/cromsatin available in material Nikral Legra Zama Uni 3717 on anchor rose for bolt through fixing.

Maniglia per finestra *Window Handle*

H 163 F



H 163 FRS-41



Certificato secondo ÖNORM B 3859
Maniglie per porte antincendio
*Certified in compliance with ÖNORM B 3859
Leverhandles for fire resisting doors*

H 421
Serie Didone
design Piero Russi



78



H 421 Serie Didone

design Piero Russi

Materiale Nikrall Lega Zama UNI 3717

Material Nikrall Lega Zama UNI 3717



H 421 R8

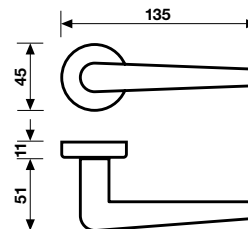

Finiture

Finishes

Maniglia per finestra

Window Handle

79



Cromo



Cromsatin



Zirtanio Oro lucido

H 421 FRS-41



H 419

Serie Bordeaux

design Valli Workshop



80



H 419 Serie Bordeaux

design Valli Workshop



Materiale Acciaio Inox AISI 304

Material Stainless Steel AISI 304



H 419 R8

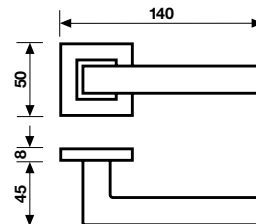

Finiture

Finishes

Maniglia per finestra

Window Handle

Nella stessa serie sono disponibili

Coordinated accessories

81



Satinato

H 419 FRS-41



K 465

Pomolo per porta

Door knob _____ pag. 114



Certificato secondo ÖNORM B 3859
Maniglie per porte antincendio

*Certified in compliance with ÖNORM B 3859
Leverhandles for fire resisting doors*

H 417

Serie Indigo

design Valli Workshop



82



H 417 Serie Indigo

design Valli Workshop

Valli&Valli

ASSA ABLOY

Materiale Nikrall Lega Zama UNI 3717

Material Nikrall Lega Zama UNI 3717



H 417 R8

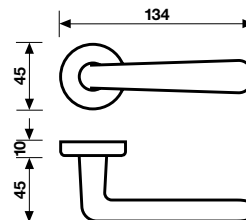

Finiture

Finishes

Maniglia per finestra

Window Handle

83

H 417 FRS-41



Orolux

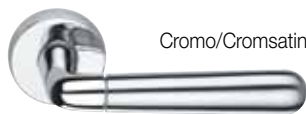

Cromo/Cromsatin



Cromsatin



Orolux/Orluxsat



H 416

Serie Garnet

design Valli Workshop



84



H 416 Serie Garnet

design Valli Workshop

Valli&Valli

ASSA ABLOY

Materiale Acciaio Inox AISI 304

Material Acciaio Inox AISI 304



H 416 R8

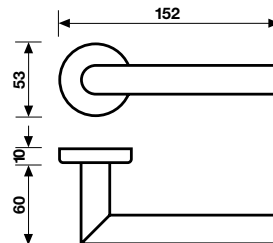

Finiture

Finishes

Maniglia per finestra

Window Handle

85



Satinato

H 416 FRS-41



Certificato secondo EN1906:2010-09

Classe **47-0130B**

Certified in compliance with EN1906:2010-09

Class **47-0130B**

H 415

Serie Scarlet

design Valli Workshop



86



H 415 Serie Scarlet

design Valli Workshop

Materiale Acciaio Inox AISI 304

Material Acciaio Inox AISI 304



H 415 R8

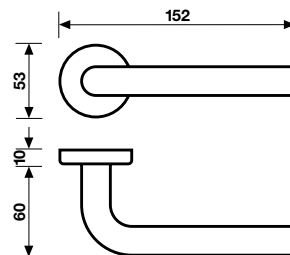

Finiture

Finishes

Maniglia per finestra

Window Handle

87



Satinato

H 415 FRS-41



H 414

Serie Amber

design Valli Workshop



88



H 414 Serie Amber

design Valli Workshop

Valli&Valli

ASSA ABLOY

Materiale Acciaio Inox AISI 304

Material Acciaio Inox AISI 304



H 414 R8

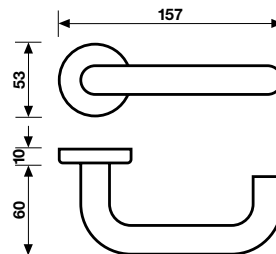

Finiture

Finishes

Maniglia per finestra

Window Handle

89



Satinato

H 414 FRS-41



Certificato secondo EN1906:2010-09

Classe **47-0130B**

Certified in compliance with EN1906:2010-09

Class **47-0130B**

H 412

Serie Lilla

design Valli Workshop



90



H 412 Serie Lilla

design Valli Workshop

Materiale Ottone
Material Brass



H 412 R8

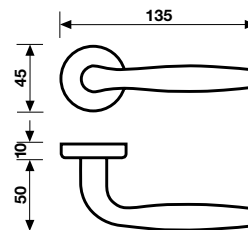

Finiture
Finishes

Maniglia per finestra
Window Handle

91

H 412 FRS-41



Oro lucido



Cromsatin



H 44

Serie Pink

design Valli Workshop



92

H 44 Serie Pink

design Valli Workshop

Materiale Nikrall Lega Zama UNI 3717

Material Nikrall Lega Zama UNI 3717



H 44 R8

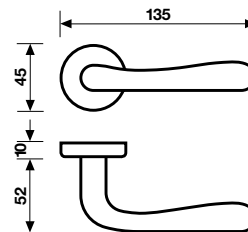

Finiture

Finishes

Maniglia per finestra

Window Handle

93



Oro zecchino



Orolux



Cromsatin

H 44 F



H 44 FRS-41



H 186

design Valli Workshop



94



H 186

design Valli Workshop

Materiale Ottone/Acciaio Inox
Material Brass/Stainless Steel



H 186 RG

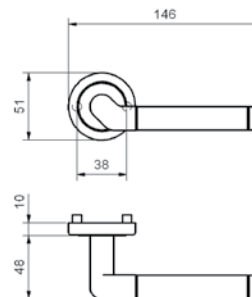

Articolo solo disponibile con sottorosetta con perni per viti passanti
Article only available on anchor rose for bolt through fixing

Valli&Valli
ASSA ABLOY

Finiture
Finishes



Crominox

Maniglia per finestra
Window Handle

H 186 FRS-41



Certificato secondo ÖNORM B 3859
Maniglie per porte antincendio
Certified in compliance with ÖNORM B 3859
Leverhandles for fire resisting doors

H 1735

design Valli Workshop



96



H 1735

design Valli Workshop

Materiale Ottone

Material Brass



H 1735 RG

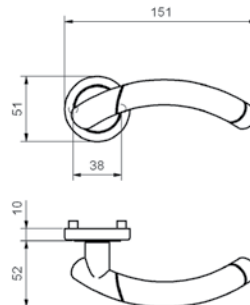

Valli&Valli

ASSA ABLOY

Articolo solo disponibile con sottorosetta con perni per viti passanti
Article only available on anchor rose for bolt through fixing

Finiture

Finishes

Maniglia per finestra

Window Handle

97

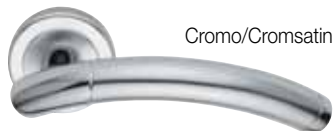

Cromo/Cromsatin



Oro/Orsatin

H 1735 FRS-41



Certificato secondo ÖNORM B 3859
Maniglie per porte antincendio
Certified in compliance with ÖNORM B 3859
Leverhandles for fire resisting doors

H 4742

design Valli Workshop

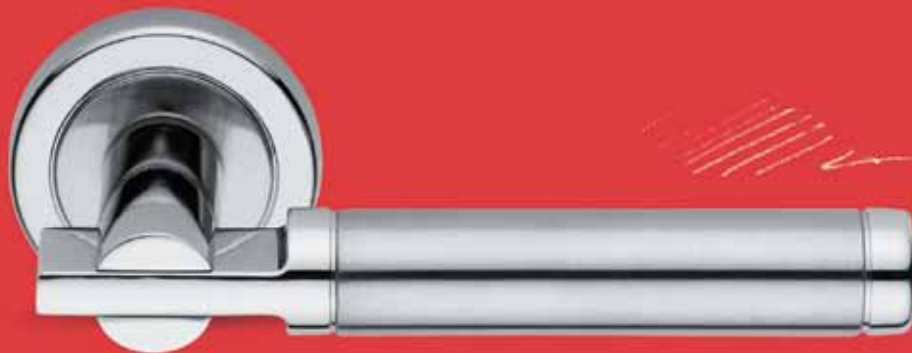

98



H 4742

design Valli Workshop

Materiale Nikrall Lega Zama Uni 3717 / Acciaio Inox

Material Nikrall Lega Zama Uni 3717 / Stainless Steel



H 4742 RG

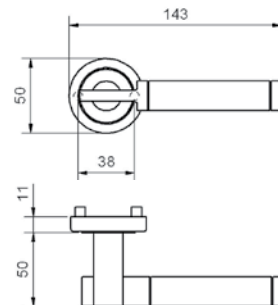

Valli&Valli
ASSA ABLOY

Articolo solo disponibile con sottorosetta con perni per viti passanti
Article only available on anchor rose for bolt through fixing

Finiture
Finishes

Maniglia per finestra
Window Handle

99



Crominox

H 4742 FRS-41



H 4734

design Valli Workshop



100

H 4734

design Valli Workshop

Materiale Ottone/Acciaio Inox
Material Brass/Stainless Steel

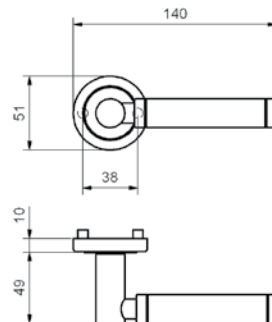

Valli&Valli
ASSA ABLOY

Articolo solo disponibile con sottorosetta con perni per viti passanti
Article only available on anchor rose for bolt through fixing

Finiture
Finishes



Maniglia per finestra
Window Handle

H 4734 FRS-41



H 4730

design Valli Workshop



102



H 4730

design Valli Workshop

Materiale Nikrall Lega Zama Uni 3717 / Acciaio Inox

Material Nikrall Lega Zama Uni 3717 / Stainless Steel



H 4730 RG

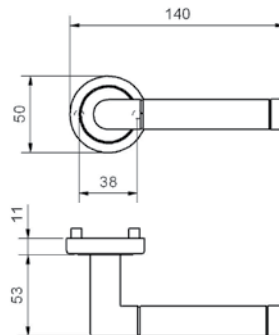

Valli&Valli

ASSA ABLOY

Articolo solo disponibile con sottorosetta con perni per viti passanti
Article only available on anchor rose for bolt through fixing

Finiture

Finishes

Maniglia per finestra

Window Handle

103



Crominox

H 4730 FRS-41



Certificato secondo ÖNORM B 3859
Maniglie per porte antincendio

*Certified in compliance with ÖNORM B 3859
Leverhandles for fire resisting doors*

H 4707

design Valli Workshop



104



H 4707

design Valli Workshop

Materiale Nikrall Lega Zama Uni 3717

Material Nikrall Lega Zama Uni 3717



H 4707 RG

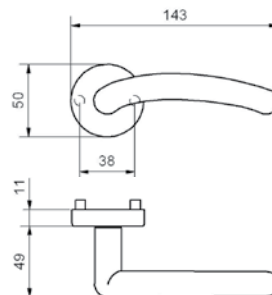

Valli&Valli
ASSA ABLOY

Articolo solo disponibile con sottorosetta con perni per viti passanti
Article only available on anchor rose for bolt through fixing

Finiture
Finishes



Cromsatin

Maniglia per finestra
Window Handle

H 4707 FRS-41



H 4705

design Valli Workshop

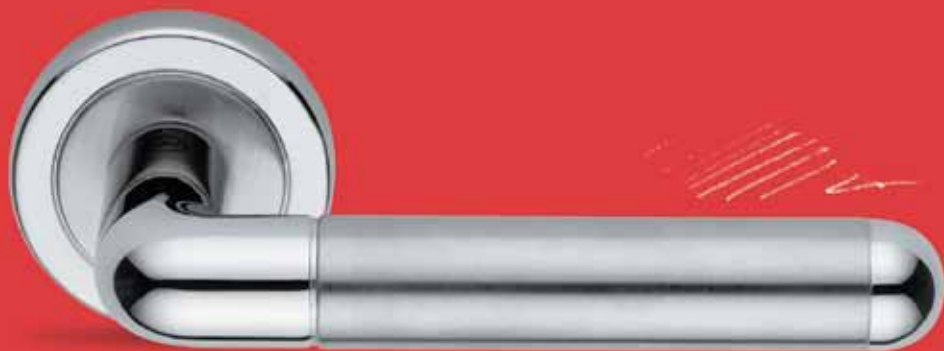

106



H 4705

design Valli Workshop

Materiale Nikrall Lega Zama Uni 3717/Acciaio Inox

Material Nikrall Lega Zama Uni 3717/Stainless Steel



H 4705 RG

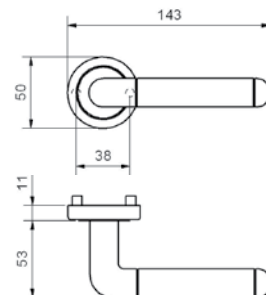

Valli&Valli

ASSA ABLOY

Articolo solo disponibile con sottorosetta con perni per viti passanti
Article only available on anchor rose for bolt through fixing

Finiture

Finishes

Maniglia per finestra

Window Handle

107



Crominox

H 4705 FRS-41



H 4705 P8



Certificato secondo ÖNORM B 3859

Maniglie per porte antincendio

Certified in compliance with ÖNORM B 3859

Leverhandles for fire resisting doors

H 174 P

design Valli Workshop

Materiale Ottone

Material Brass

Finiture / Finishes

Oro lucido

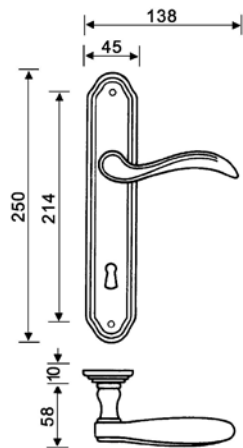

H 174 P8



H 4704 P

design Valli Workshop

Materiale Ottone

Material Brass

Finiture / Finishes

Oro/Orsatin

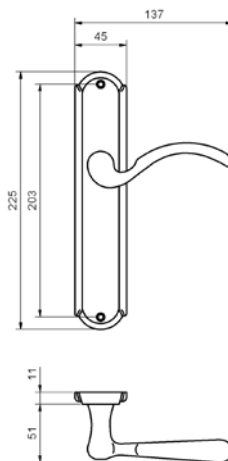

H 4704 P8



K 1168

design Valli Workshop

Materiale Ottone

Material Brass

Finiture / Finishes

Cromo

Cromsatin

K 1166

design Valli Workshop

Materiale Nikrall Lega Zama UNI 3717

Material Nikrall Lega Zama UNI 3717

Finiture / Finishes

Cromo

Cromsatin

Zirtanio Oro Lucido

Valli&Valli

ASSA ABLOY

K 1168 R8
K 1168 R8 Y

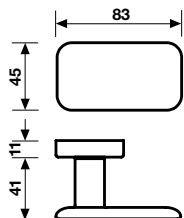

K 1166

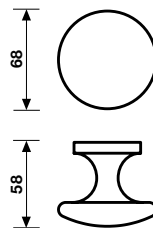

K 1165 Serie Bess

design Yoshimi Kono

Materiale Nikrall Lega Zama UNI 3717

Material Nikrall Lega Zama UNI 3717

Finiture / Finishes

Cromo

Cromsatin/Cromo

K 1162

design Valli Workshop

Materiale Ottone

Material Brass

Finiture / Finishes

Oro lucido

Anticato

Brunito

Zirtanio Oro lucido

110

K 1165 R8
K 1165 R8 Y

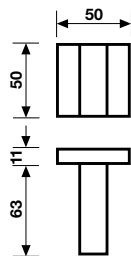

K 1162 A
K 1162 Mis/size 80

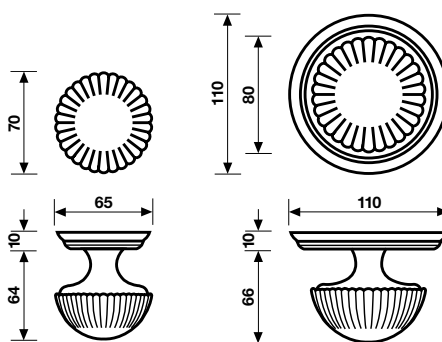

K 1160

design Valli Workshop

Materiale Ottone

Material Brass

Finiture / Finishes

Oro lucido

Ottone naturale

Cromsatin

Zirtanio Oro lucido

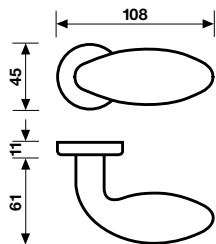

K 1155

design Valli Workshop

Materiale Ottone

Material Brass

Finiture / Finishes

Oro lucido

Orsatin

Cromo

Cromsatin

Anticato

Brunito

Zirtanio Oro lucido

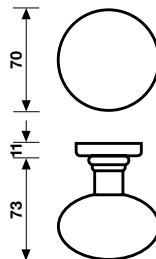

K 1155

design Valli Workshop

Materiale Ottone

Material Brass

Finiture / Finishes

Oro lucido
Orsatin
Ottone naturale
Cromo
Cromsatin
Anticato
Brunito

K 1155 R8
K 1155 R8 Y

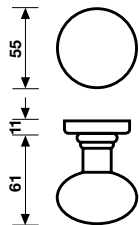

K 1153

design Valli Workshop

Materiale Ottone

Material Brass

Finiture K1153 R SB

Finishes K1153 R SB

Oro lucido
Cromsatin

Finiture K1153 R Y

Finishes K1153 R Y

Oro lucido
Cromsatin
Zirtanio oro lucido

K 1153 R SB
K 1153 R Y

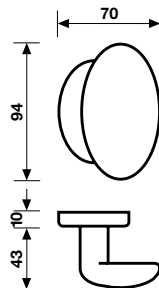

K 1153 PY

design Valli Workshop

Materiale Ottone

Material Brass

Finiture / Finishes

Oro lucido

Cromsatin

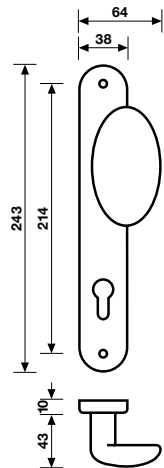

K 1153 PY D/S 85



K 121 Serie Luigi XVI

design Valli Workshop

Materiale Ottone

Material Brass

Finiture / Finishes

Oro lucido

Ottone naturale antico

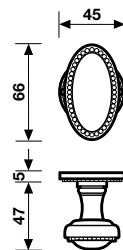

K 121 R8
K 121 R8 Y



K 120 Serie Luigi XV

design Valli Workshop

Materiale Ottone

Material Brass

Finiture / Finishes

Oro lucido

Ottone naturale antico

K 120 R8
K 120 R8 Y

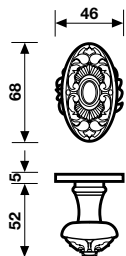

K 465

design Valli Workshop

Materiale Acciaio Inox AISI 304

Material Stainless Steel AISI 304

Finiture / Finishes

Satinato

K465 R8
K465 R8 Y

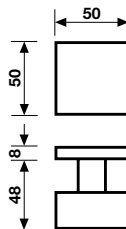

K 1730

design Valli Workshop

Materiale Ottone

Material Brass

Finiture / Finishes

Oro

Cromo

Cromsatin

Nikmat

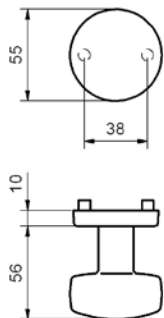

K 1730



Articolo solo disponibile con sottorosetta con perni per viti passanti
Article only available on anchor rose for bolt through fixing

K 142

design Valli Workshop

Materiale Ottone

Material Brass

Finiture / Finishes

Oro

Cromo

Cromsatin

Nikmat

Zirtoro

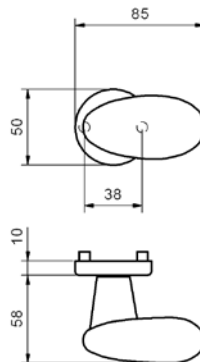

K 142



Articolo solo disponibile con sottorosetta con perni per viti passanti
Article only available on anchor rose for bolt through fixing

K 1228 Serie Bess

design Yoshimi Kono

Materiale Ottone

Material Brass

Finiture / Finishes

Cromo
Cromsatin

Interasse

Centre distance
300 mm

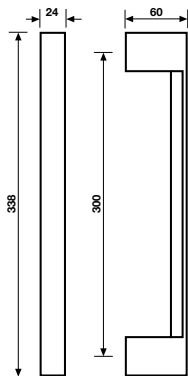

K 1226 Serie Fedra

design Jean-Baptiste Sibertin Blanc

Materiale Ottone

Material Brass

Finiture / Finishes

Oro lucido
Cromsatin/Cromo

Interasse

Centre distance
300 mm

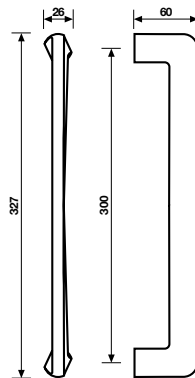

K 1224

design Valli Workshop

Materiale Acciaio Inox AISI 304

Material Stainless Steel AISI 304

Finiture / Finishes

Satinato

Interasse

Centre distance

224 mm

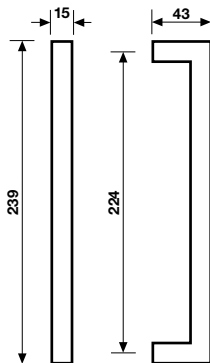

K 1219

design Valli Workshop

Materiale Acciaio Inox AISI 304

Material Stainless Steel AISI 304

Finiture / Finishes

Satinato

Interasse

Centre distance

224 mm

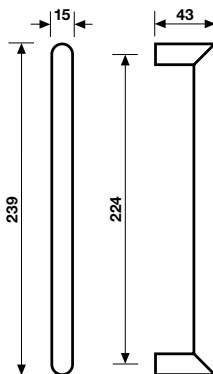

K 1210

design Valli Workshop

Materiale Ottone

Material Brass

Finiture / Finishes

Oro lucido

Orsatin

Cromsatin

Anticato

Zirtanio Oro Lucido

Interasse

Centre distance

210 mm

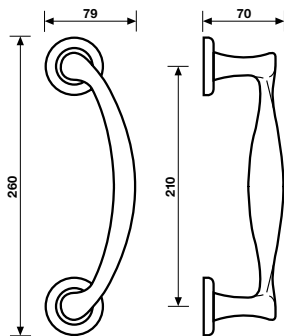

K 1188

design Valli Workshop

Materiale Ottone

Material Brass

Finiture / Finishes

Oro lucido

Orsatin

Cromsatin

Brunito

Zirtanio Oro Lucido

Interasse

Centre distance

210 mm

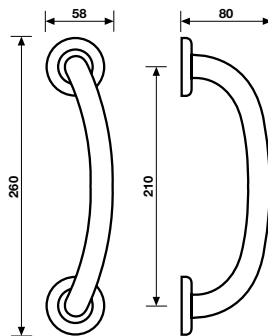

K 169 Serie Bess

design Yoshimi Kono

Materiale Ottone

Material Brass

Finiture / Finishes

Cromo

Cromsatin/Cromo

Cromsatin

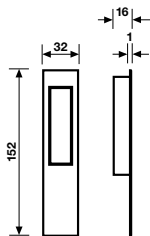
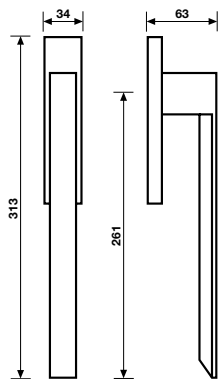

K 169
K 169 Y
K 169 PL N



K 163

design Valli Workshop

Valli&Valli

ASSA ABLOY

Materiale Ottone

Material Brass

Finiture / Finishes

Oro lucido

Ottone naturale

Cromsatin

Brunito

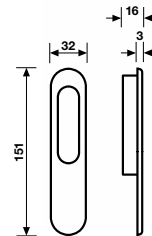
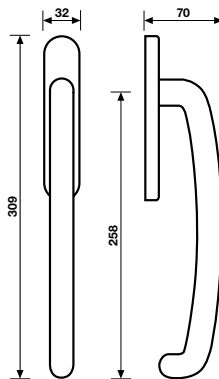

K 163
K 163 Y
K 163 PL N



K 466

design Valli Workshop

Materiale Acciaio Inox AISI 304

Material Stainless Steel AISI 304

Finiture / Finishes

Satinato

Interasse

Centre distance

300 mm

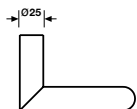
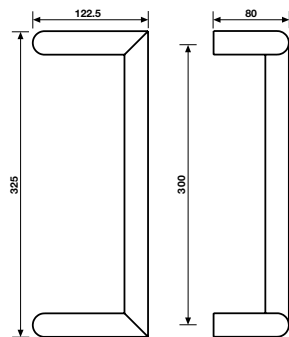

K 466 25
K 466 S25

K 464

design Valli Workshop

Materiale Acciaio Inox AISI 304

Material Stainless Steel AISI 304

Finiture / Finishes

Satinato

Interasse

Centre distance

300 mm

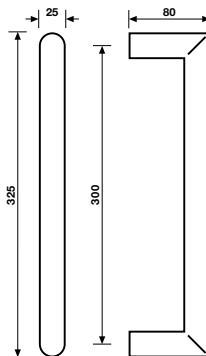

K 464 25
K 464 S25



K 1232 Serie Bess

design Yoshimi Kono

Materiale Ottone
Material Brass

Finiture / Finishes
Cromo
Cromsatin



Kit incasso completo di maniglia di trascinamento senza serratura
Inset handle kit with recessed finger pull, without lock

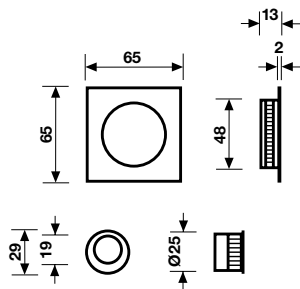

K 1230 Serie Bess

design Yoshimi Kono

Materiale Ottone
Material Brass

Finiture / Finishes
Cromo
Cromsatin



Kit incasso con nottolino completo di serratura e maniglia di trascinamento
Inset handle kit with thumb turn complete with lock and recessed finger pull

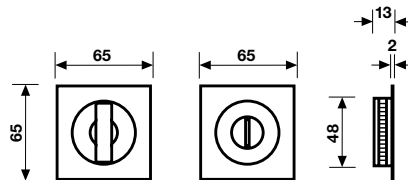

K 1212 Serie Orfeide

design Scigno

Materiale Ottone
Material Brass

Finiture / Finishes
Oro lucido
Cromsatin



122

Kit incasso completo di maniglia di trascinamento senza serratura
Inset handle kit with recessed finger pull, without lock

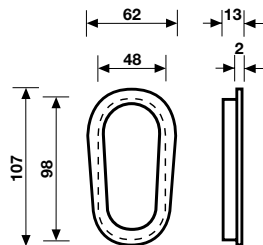

K 1211 Serie Orfeide

design Scigno

Materiale Ottone
Material Brass

Finiture / Finishes
Oro lucido
Cromsatin



Kit incasso con nottolino completo di serratura e maniglia di trascinamento
Inset handle kit with thumb turn complete with lock and recessed finger pull

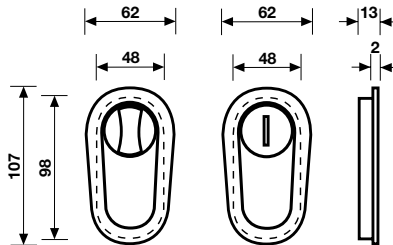

K 1206 Serie Tancredi

design Valli Workshop

Materiale Ottone

Material Brass

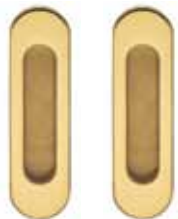

Finiture / Finishes

Oro lucido
Orsatin
Cromo
Cromsatin
Anticato

Kit incasso completo di maniglia di
trascinamento senza serratura
*Inset handle kit with recessed finger
pull, without lock*

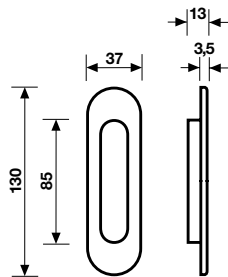

K 1205 Serie Tancredi

design Valli Workshop

Materiale Ottone

Material Brass



Finiture / Finishes

Oro lucido
Orsatin
Cromo
Cromsatin
Anticato

Kit incasso con foro chiave completo di chiave
snodata, serratura e maniglia di trascinamento
*Inset handle kit with key hole complete
with jointed key, lock and recessed finger pull*

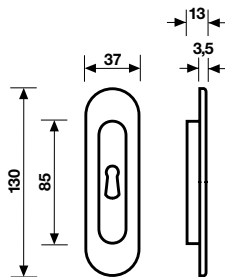

K 1204 Serie Tancredi

design Valli Workshop

Materiale Ottone

Material Brass

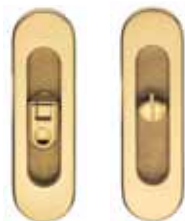

Finiture / Finishes

Oro lucido
Orsatin
Cromo
Cromsatin
Anticato

Kit incasso con nottolino completo di serratura
e maniglia di trascinamento

*Inset handle kit with thumb turn complete
with lock and recessed finger pull*

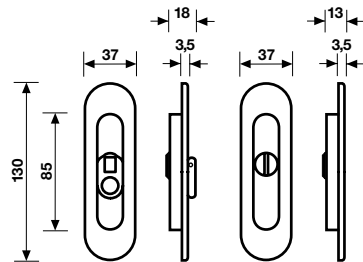

K 1203 Serie Trittico

design Valli Workshop

Materiale Ottone

Material Brass



Finiture / Finishes

Oro lucido
Orsatin
Ottone naturale
Cromo
Cromsatin
Anticato

Maniglia di trascinamento

Recessed finger pull



K 1202 Serie Trittico

design Valli Workshop

Materiale Ottone

Material Brass



Finiture / Finishes

Oro lucido

Orsatin

Ottone naturale

Cromo

Cromsatin

Anticato

Brunito

Kit incasso completo di maniglia di
trascinamento senza serratura

*Inset handle kit complete with recessed
finger pull, without lock*

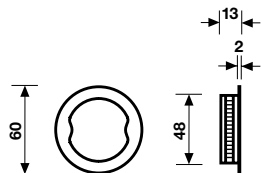

K 1201 Serie Trittico

design Valli Workshop

Materiale Ottone

Material Brass



Finiture / Finishes

Oro lucido

Orsatin

Cromo

Cromsatin

Anticato

Kit incasso con foro chiave completo di chiave
snodata, serratura e maniglia di trascinamento

*Inset handle kit with key hole complete with
jointed key, lock and recessed finger pull*

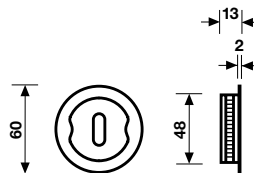

K 1200 Serie Trittico

design Valli Workshop

Materiale Ottone

Material Brass



Finiture / Finishes

Oro lucido

Orsatin

Ottone naturale

Cromo

Cromsatin

Anticato

Brunito

Kit incasso con nottolino completo
di serratura e maniglia di trascimento
*Inset handle kit with thumb turn complete
with lock and recessed finger pull*

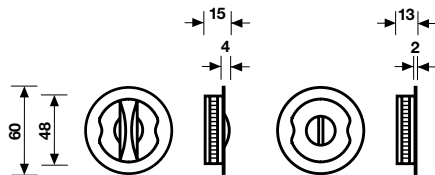

K 1195

design Valli Workshop

Materiale Ottone

Material Brass

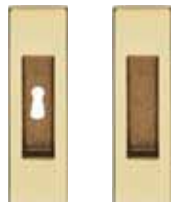

Finiture / Finishes

Oro lucido

Cromo

Cromsatin

K 1195
K 1195 SFC

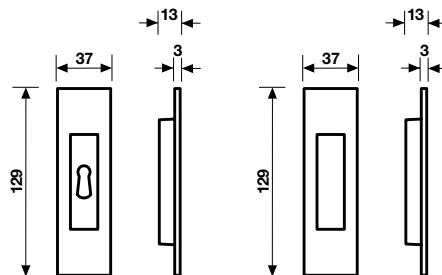

K 1186

design Valli Workshop

Materiale Ottone
Material Brass

Finiture / Finishes
Oro lucido
Orsatin
Ottone naturale
Cromo
Cromsatin
Anticato
Nikmatt
Brunito



K 1186
K 1186 SFC

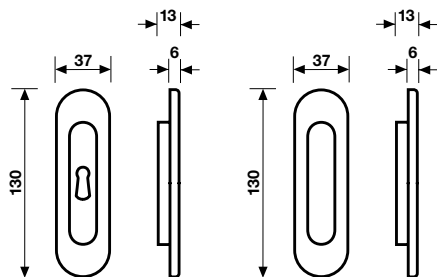

K 4202

design Valli Workshop

Materiale Ottone
Material Brass

Finiture / Finishes
Oro lucido
Cromsatin



Kit incasso completo di maniglia di
trascinamento senza serratura
*Inset handle kit complete with recessed
finger pull, without lock*

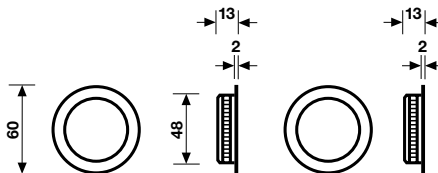

K 4200

design Valli Workshop

Materiale Ottone

Material Brass

Finiture / Finishes

Oro lucido

Cromsatin



128

Kit incasso con nottolino completo
di serratura e maniglia di trascimento
*Inset handle kit with thumb turn complete
with lock and recessed finger pull*

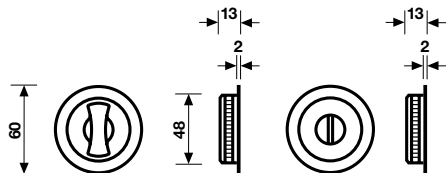

H 421 R8 / K 1166 PB

Kit Porte blindate / *Kit for armoured door*

Materiale Nikrall Lega Zama UNI 3717

Material Nikrall Lega Zama UNI 3717

Finiture / Finishes

Cromo

Cromsatin

Zirtanio Oro lucido

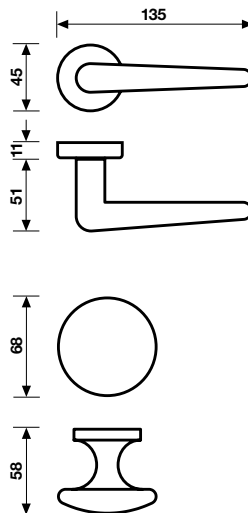

L 193

design Valli Workshop

Materiale Ottone
Material Brass

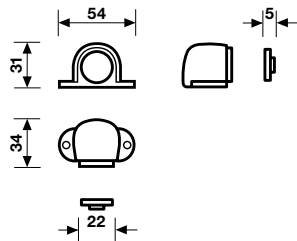

Finiture / Finishes
Oro lucido
Cromo
Cromsatin
Anticato



Fermaporta
con calamita
*Door stops
with magnet*

L 190

design Valli Workshop

Materiale Ottone
Material Brass

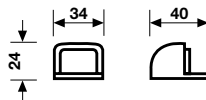

Finiture / Finishes
Oro lucido
Cromo
Cromsatin
Brunito



L 490

design Valli Workshop

Materiale Acciaio Inox AISI 304
Material Stainless Steel AISI 304

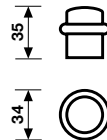

Finiture / Finishes
Satinato
Lucido



E 1009

design Valli Workshop

Materiale Ottone
Material Brass

Finiture / Finishes
Cromsatin



130

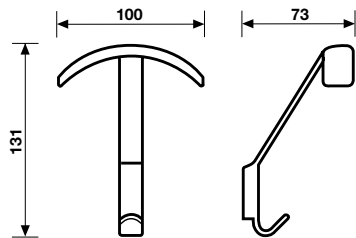

E 525

design Valli Workshop

Materiale Nikrall Lega Zama UNI 3717
Material Nikrall Lega Zama UNI 3717

Finiture / Finishes
Patiné
Fumé

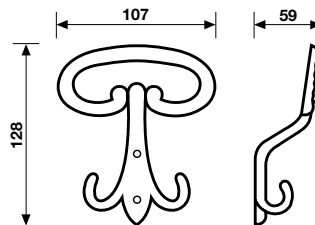

E 183

design Valli Workshop

Materiale Ottone
Material Brass

Finiture / Finishes
Oro lucido
Cromo
Cromsatin
Brunito

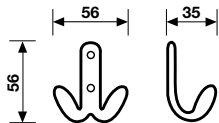

E 182

design Valli Workshop

Materiale Ottone
Material Brass

Finiture / Finishes
Oro lucido
Cromo
Cromsatin
Brunito

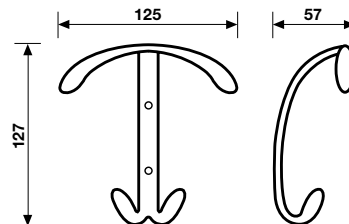

E 180

design Valli Workshop

Materiale Ottone
Material Brass

Finiture / Finishes
Oro lucido
Cromsatin



132

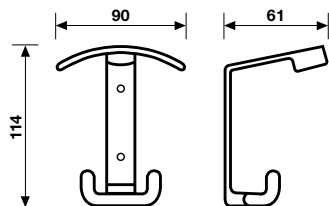

V&V Maniglie per Mobile / *Furniture fittings*

A 2068

design Michel Boucquillon

Materiale Nikrall Lega Zama UNI 3717

Material Nikrall Lega Zama UNI 3717

Finiture / Finishes

Cromo
Nikmatt

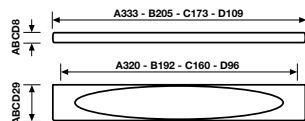

A 2062

design Valli Workshop

Materiale Nikrall Lega Zama UNI 3717

Material Nikrall Lega Zama UNI 3717

Finiture / Finishes

Cromo
Nikmatt

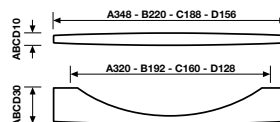

134

A 2061

design Valli Workshop

Materiale Nikrall Lega Zama UNI 3717

Material Nikrall Lega Zama UNI 3717

Finiture / Finishes

Cromo
Nikmatt

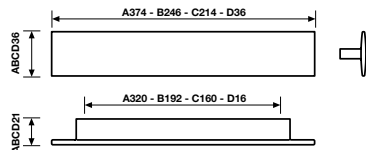
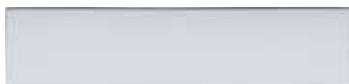

A 2057

design Valli Workshop

Materiale Nikrall Lega Zama UNI 3717

Material Nikrall Lega Zama UNI 3717

Finiture / Finishes

Cromo
Nikmatt

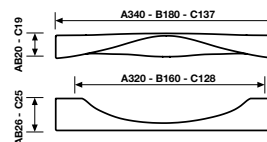

A 2050

design Carlesi Design

Materiale Nikrall Lega Zama UNI 3717
Material Nikrall Lega Zama UNI 3717

Finiture / Finishes
Cromo

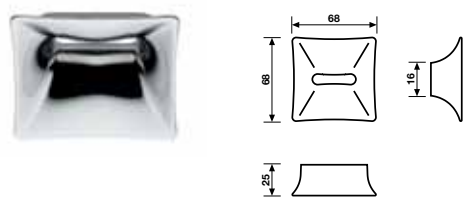

A 2047

design Giancarlo Vegni

Materiale Nikrall Lega Zama UNI 3717
Material Nikrall Lega Zama UNI 3717

Finiture / Finishes
Nikmatt

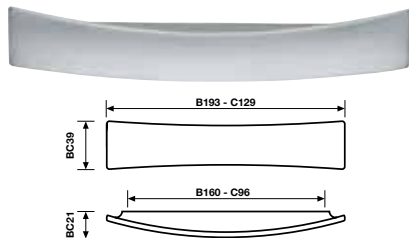

A 2048

design Carlesi Design

Materiale Nikrall Lega Zama UNI 3717
Material Nikrall Lega Zama UNI 3717

Finiture / Finishes
Cromo

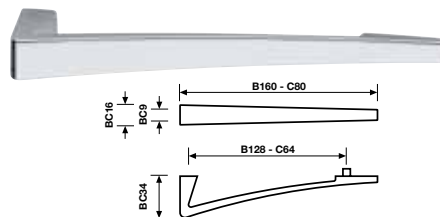

A 2046

design Carlesi Design

Materiale Nikrall Lega Zama UNI 3717
Material Nikrall Lega Zama UNI 3717

Finiture / Finishes
Cromo
Nikmatt

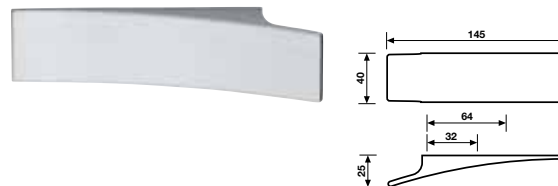

A 2042

design Frank O. Gehry

Materiale Nikrall Lega Zama UNI 3717

Material Nikrall Lega Zama UNI 3717



Finiture / Finishes

Cromo
Cromsatin

A 2041

design Giancarlo Vegni

Materiale Nikrall Lega Zama UNI 3717 e ottone

Material Nikrall Lega Zama UNI 3717 and brass

Finiture / Finishes

Cromo/Cromsatin
Nikmatt

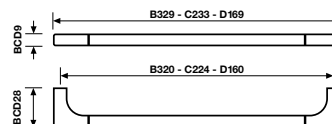

A 2027

design Giancarlo Vegni

Materiale Nikrall Lega Zama UNI 3717

Material Nikrall Lega Zama UNI 3717

Finiture / Finishes

Cromo
Nikmatt

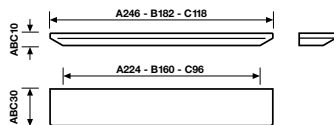

A 2026

design Marianelli e Sordina

Materiale Nikrall Lega Zama UNI 3717

Material Nikrall Lega Zama UNI 3717

Finiture / Finishes

Cromo
Nikmatt

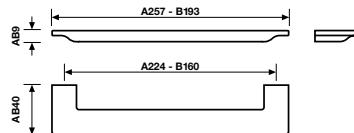

A 2025

design Antonio Citterio

Materiale Acciaio Inox

Material Stainless steel

Finiture / Finishes

Satinato

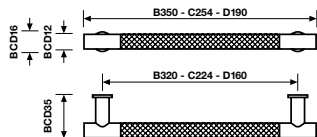

A 295

design Giancarlo Vegni

Materiale Nikrall Lega Zama UNI 3717 e ottone

Material Nikrall Lega Zama UNI 3717 and brass

Finiture / Finishes

Cromo
Cromsatin

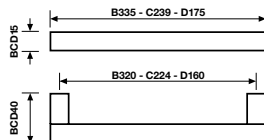

A 2024

design Carlesi Design

Materiale Nikrall Lega Zama UNI 3717

Material Nikrall Lega Zama UNI 3717

Finiture / Finishes

Cromo A+B
Nikmatt B

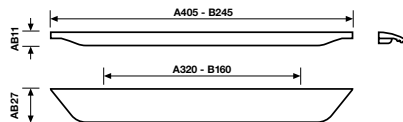

A 288

design Giancarlo Vegni

Materiale Nikrall Lega Zama UNI 3717e ottone

Material Nikrall Lega Zama UNI 3717 and brass

Finiture / Finishes

Nikmatt

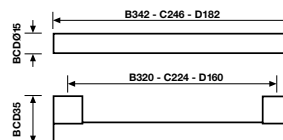

A 284

design Eero Aarnio

Materiale Nikrall Lega Zama UNI 3717

Material Nikrall Lega Zama UNI 3717

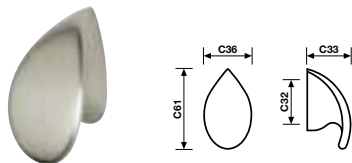

Finiture / Finishes

Cromo
Nikmatt

A 283

design Valli Workshop

Materiale Acciaio Inox

Material Stainless steel

Finiture / Finishes

Satinato

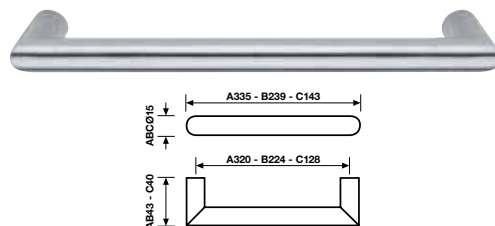

A 282

design Valli Workshop

Materiale Acciaio Inox

Material Stainless steel

Finiture / Finishes

Satinato

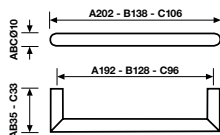

A 278

design Eero Aarnio

Materiale Nikrall Lega Zama UNI 3717

Material Nikrall Lega Zama UNI 3717

Finiture / Finishes

Nikmatt

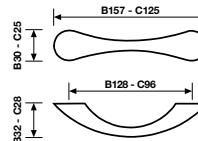

A 275

design Valli Workshop

Materiale Nikrall Lega Zama UNI 3717 e ottone *Finiture / Finishes*
Material Nikrall Lega Zama UNI 3717 and brass Nikmatt

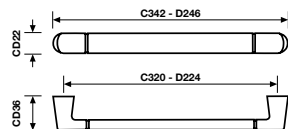

A 252

design Eero Aarnio

Materiale Nikrall Lega Zama UNI 3717 *Finiture / Finishes*
Material Nikrall Lega Zama UNI 3717 Nikmatt

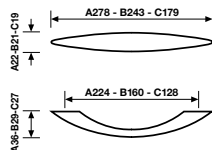

A 256

design Eero Aarnio

Materiale Nikrall Lega Zama UNI 3717 *Finiture / Finishes*
Material Nikrall Lega Zama UNI 3717 Nikmatt

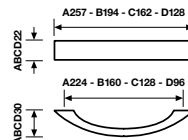

A 240

design Eero Aarnio

Materiale Nikrall Lega Zama UNI 3717 *Finiture / Finishes*
Material Nikrall Lega Zama UNI 3717 Cromo

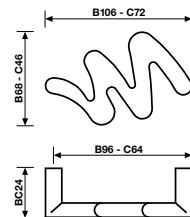

A 237

design Eero Aarnio

Materiale Nikrall Lega Zama UNI 3717

Material Nikrall Lega Zama UNI 3717

Finiture / Finishes

Nikmatt

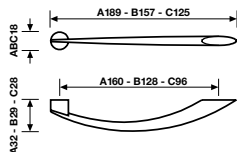

A 231

design Valli Workshop

Materiale Nikrall Lega Zama UNI 3717

Material Nikrall Lega Zama UNI 3717

Finiture / Finishes

Nikmatt

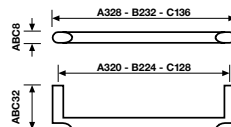

A 230

design Valli Workshop

Materiale Nikrall Lega Zama UNI 3717

Material Nikrall Lega Zama UNI 3717

Finiture / Finishes

Nikmatt

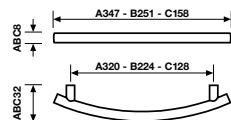

A 163

design Sottsass Associati

Materiale Ottone

Material Brass

Finiture / Finishes

Cromsatin

Oro lucido

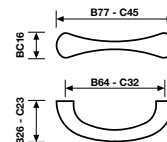

A 792

design Valli Workshop

Materiale Ottone

Material Brass

Finiture / Finishes

Oro
Patiné

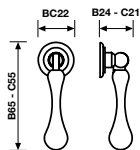

A 791

design Valli Workshop

Materiale Ottone

Material Brass

Finiture / Finishes

Oro
Patiné

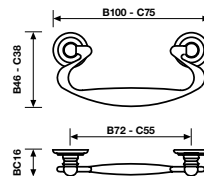

A 755/2

design Valli Workshop

Materiale Ottone

Material Brass

Finiture / Finishes

Patiné

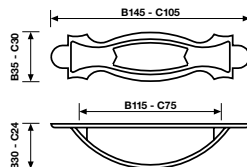
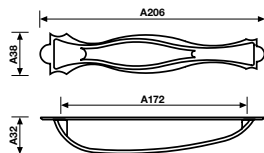

A 753/2

design Valli Workshop

**Materiale Nikrall Lega Zama UNI 3717
e ferro battuto**

Material Nikrall Lega Zama UNI 3717

Finiture / Finishes
Fumé

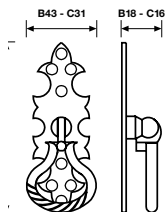

A 752/2

design Valli Workshop

**Materiale Nikrall Lega Zama UNI 3717
e ferro battuto**

Material Nikrall Lega Zama UNI 3717

Finiture / Finishes
Fumé

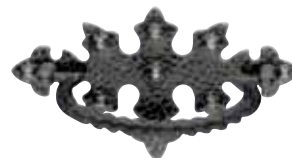
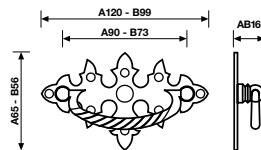

B 242

design Eero Aarnio

Materiale Ottone

Material Brass

Finiture / Finishes

Cromo

Nikmatt

Oro lucido

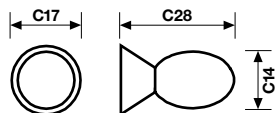

B 239

design Gost & Schreyer

Materiale Ottone

Material Brass

Finiture / Finishes

Cromo

Nikmatt

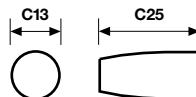

B 237

design Valli Workshop

Materiale Porcellana e Ottone

Material Porcelain and Brass

Finiture / Finishes

Bianco

Fiorato

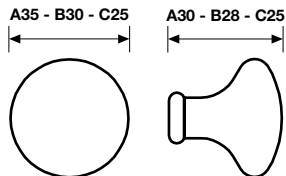

B 128

design Valli Workshop

Materiale Ottone

Material Brass

Finiture / Finishes

Bianco

Oro

Patiné

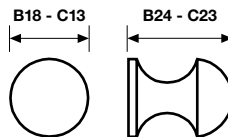

B 120

design Valli Workshop

Materiale Ottone

Material Brass

Finiture / Finishes

Oro

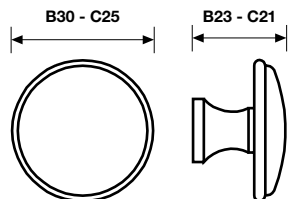

B 33

design Valli Workshop

Materiale Ottone

Material Brass

Finiture / Finishes

Cromo
Cromsatin
Oro

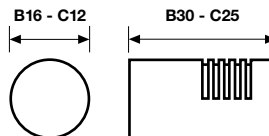

144

B 985

design Valli Workshop

Materiale Nikrall Lega Zama UNI 3717 e Ferro battuto

Material Nikrall Lega Zama UNI 3717

Finiture / Finishes

Fumè

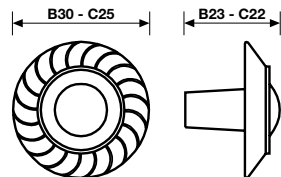

B 985 PL

design Valli Workshop

Materiale Ferro

Material Iron

Finiture / Finishes

Fumè

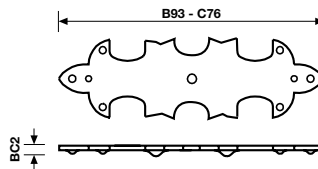

DCRN 752

design Valli Workshop

Materiale Ferro

Material Iron

Finiture / Finishes

Fumé

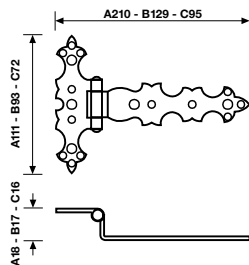
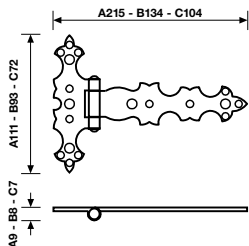

DCRN 152

design Valli Workshop

Materiale Ferro

Material Iron

Finiture / Finishes

Fumé

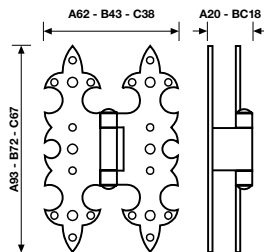
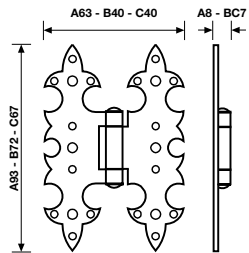

ASSA ABLOY Italia S.p.A.

Sede di Milano / Milan Unit
Via Concordia, 16
20838 Renate (MB) - Italy
info@assaabloy.it
www.assaabloy.it
www.vallievalli.com

**Ufficio Commerciale Italia
Italian Business Office**

Tel. +39 0362 982271
Fax +39 0362 982235
valli.italia@assaabloy.it

**Ufficio Commerciale Export
Export Business Office**

Tel. +39 0362 982260
Fax +39 0362 982214
valli.export@assaabloy.it

Assa Abloy si riserva il diritto di apportare eventuali modifiche atte a migliorare i prodotti, senza alcun preavviso.
Le misure dei nostri prodotti indicate nel presente catalogo si intendono approssimative.

*Assa Abloy reserve the right to make eventual modifications directed towards improving their products, without previous notice.
The sizes of our products indicated in this catalogue are indicative.*

ASSA ABLOY è leader mondiale nei sistemi di chiusura ed apertura delle porte adatti a soddisfare ogni requisito di sicurezza, protezione e comfort dell'utilizzatore.

ASSA ABLOY is the global leader in door opening solutions, dedicated to satisfying end-user needs for security, safety and convenience.



ASSA ABLOY

ASSA ABLOY, the global leader in door opening solutions

ASSA ABLOY