

ARIENI

MANIGLIE FATTE IN ITALIA

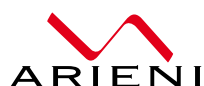



Non amiamo le lunghe presentazioni, pagine e pagine con immagini, spesso artefatte, di impianti e macchinari stupefacenti, corredate da enunciazioni su perfetta organizzazione e credibilità commerciale.

Non vogliamo presentarci così, ma semplicemente per quello che siamo e che facciamo, una azienda italiana, artigiana, a carattere familiare, che produce essenzialmente guarniture per porta, distribuendole ad un eccellente rapporto PREZZO/QUALITÀ.

Detestiamo affermare che i nostri prodotti siano i migliori, o che siano i più competitivi, perchè siamo fermamente convinti che oggi sia fondamentale proporre qualità, senza però trascurare le esigenze economiche degli utilizzatori.

Qualità a prezzi accessibili e pluralità di proposte sono quindi le linee guida che ci caratterizzano.

Solo questo desideriamo anticipare nell'invitarvi a sfogliare questo volume. Qui abbiamo unito i due cataloghi della nostra produzione dove, nella prima parte sono rappresentate le nostre serie contemporanee in svariate finiture alla moda, nella seconda presentiamo i nostri articoli in stile classico antico. Un corposo ventaglio di proposte che consente di arricchire qualsiasi tipo di ambientazione.

We get bored with long introductions full of images of big machineries and installations, perfect words describing a perfect commercial organization.

We want to present ourselves for who we are and what we do: a familiar italian company that produces door handles with very good price to quality value.

We think that important for our customer is to find quality at a reasonable price and it is our main strength together with a wide range of products.

You will find here our two catalogues representing our range: modern the first part and antique-classical the second one.





CONTEMPORARY

PAGINA PAGE		PAGINA PAGE		PAGINA PAGE		
4-5		VERA	34-35		QUADRA SPORT	
6-7		CHIC	36-37		BELLA	
8-9		NIKO	38-39		GAIA	
10-11		RING	40-41		OPERA	
12-13		AREA 51	42-43		DIAMANTE	
14-15		DEA	44-45		MIZAR	
16-17		Q-CINQUE	46-47		PEGASO	
18-19		OMEGA	48-49		SMART	
20-21		SIRIO	50-51		MAREA	
22-23		PIPITA	52-53		PRESSBURG	
24-25		PIEGO	54-55		CLASSIC	
26-27		PRIMA	56-57		CASTEL	
28-29		QUADRA	58-59		MIRADUE	
30-31		BOEMIA	60-61		MERAK	
32-33		PREZIOSA	62-63		SPIRIT	
				64-65		GRETA
				66-67		ALTAIR
				68-69		MODERNA
				70-71		SOLE
				72-73		FORTUNA
				74-75		ONDA
				76-77		ARCA
				78-79		POLAR
				80-81		JOLLY
				82-83		DOLLY
				84-85		VELA
				86-87		CIGNO
				88-89		IRIS
				90-91		SCILLA
				92-93		CRAQUELÉ

BASIC











PAGINA PAGE		PAGINA PAGE		PAGINA PAGE		
96		SMART ECO	102		MIRA OTT.	
97		MIZAR ECO	103		MIRA ZAMA	
98		COMPATTA	104		KARIZ	
99		S-QUADRA	105		THEMA	
100		ALCOR	106		ATRIA	
101		CASTOR	107		PRISMA	
				108		GOTIK
				109		LUNA
				110		ASIA
				111		MACAO
				112-113		CHIAVISTELLI PER TOILETTE



ACCESSORI

PAGINA PAGE		PAGINA PAGE		PAGINA PAGE		
116-122		MANIGLIONI	130-141		KIT PER SCORREVOLI	
123-125		POMOLI SINGOLI FISSI	142		ALZANTI PER SCORREVOLI	
126-127		COPPIA POMOLI	143		BATTENTI	
128-129		KIT HOTEL	144-148		ARTICOLI PER BLINDATI	
				149		CORRIMANO E CHIUSURE
				150		SEGRETINI E CHIUSURE
				151		MANIGLIETTE PER MOBILI
				152-157		ACCESSORI

INOX

PAGINA PAGE		PAGINA PAGE		PAGINA PAGE		
160		QUADRA	162		GIRO	
160		BIG LEVA	162		CORNER	
161		AMBRA	163		TUCANA	
161		ELLISSE	163		APUS	
				164		ALZANTI
				164		POMOLI
				165-167		MANIGLIONI

ATELIER



PAGINA PAGE		PAGINA PAGE			
172-173		STILE	184-185		MANIGLIONI
174-175		TOSCANA	186-187		POMOLI
176-177		ANTIQUA	186-187		BATTENTI
178-179		RUSTICA	188-189		KIT SCORREVOLI E MINUTERIA
180-181		EPOCA	190-191		ALTRI PARTICOLARI
182-183		PRESSBURG			

VERA



MODELLO DEPOSITATO - REGISTERED MODEL



OLV
OTTONE LUCIDO VERNICIATO
POLISHED AND PAINTED BRASS



CRS
CROMO SATINATO
SATIN CHROME



NE
NERO
BLACK



BNC
BIANCO
WHITE



CODICE	DESCRIZIONE	FINITURE	IMBALLO
4701	Guarnitura con molla di ritorno su rosette coprivite Pair spring handles. Roses. Screw cover	OLV	1
		CRS	1
		NE	1
		BNC	1
4701/R	Guarnitura su rosetta rettangolare con molla di ritorno. Pair spring handles. Rectangular rose	OLV	1
		CRS	1
		NE	1
		BNC	1
4702	Maniglia movimento DK Handle DK movement	OLV	2
		CRS	2
		NE	2
		BNC	2
4704	Martellina o cremonese con impugnatura a maniglia su nuova placca rettangolare Window Handle: 7mm square spindle or mechanism	OLV	2
		CRS	2
		NE	2
		BNC	2

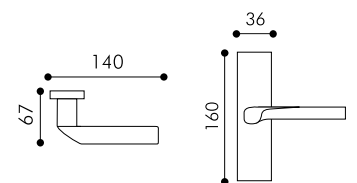
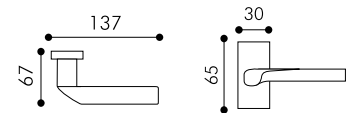
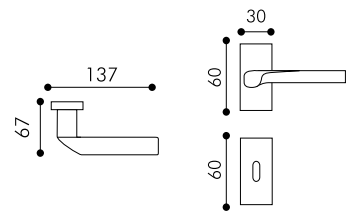
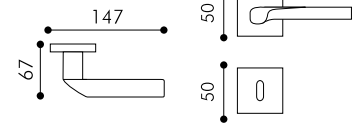

CHIC



MODELLO DEPOSITATO - REGISTERED MODEL



OCR
CROMO LUCIDO
POLISHED CHROME



CRS
CROMO SATINATO
SATIN CHROME



NE
NERO
BLACK



BNC
BIANCO
WHITE

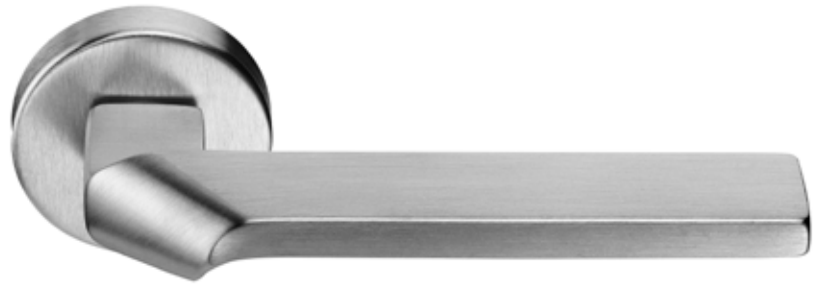

CODICE	DESCRIZIONE	FINITURE	IMBALLO
4800	Guarnitura con molla di ritorno su placche Pair spring handles. Plate	OCR	1
		CRS	1
		NE	1
		BNC	1
4801	Guarnitura con molla di ritorno su rosette coprivite Pair spring handles. Roses. Screw cover	OCR	1
		CRS	1
		NE	1
		BNC	1
4801/R	Guarnitura su rosetta ovale con molla di ritorno. Pair spring handles. Oval rose	OCR	1
		CRS	1
		NE	1
		BNC	1
4802	Maniglia movimento DK Handle DK movement	OCR	2
		CRS	2
		NE	2
		BNC	2
4804	Martellina o cremonese con impugnatura a maniglia Window Handle: 7mm square spindle or mechanism	OCR	2
		CRS	2
		NE	2
		BNC	2

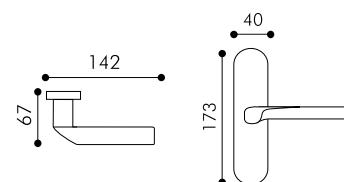
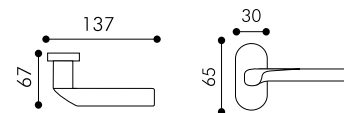
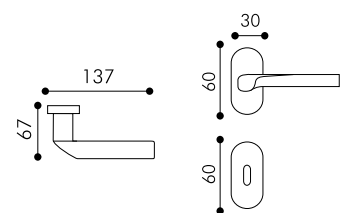
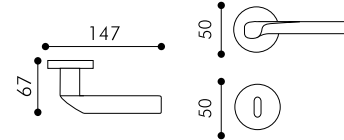
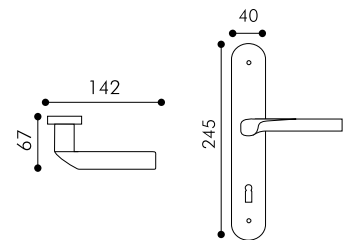

NIKO





OCR
CROMO LUCIDO
POLISHED CHROME



CRS
CROMO SATINATO
SATIN CHROME



NE
NERO
BLACK



BNC
BIANCO
WHITE

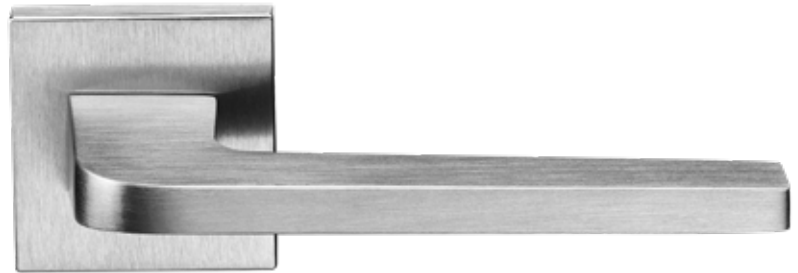

CODICE	DESCRIZIONE	FINITURE	IMBALLO
4501	Guarnitura con molla di ritorno su rosette coprivite Pair spring handles. Roses. Screw cover	OCR	1
		CRS	1
		NE	1
		BNC	1
4501/R	Guarnitura su rosetta rettangolare con molla di ritorno. Pair spring handles. Rectangular rose	OCR	1
		CRS	1
		NE	1
		BNC	1
4502	Maniglia movimento DK Handle DK movement	OCR	2
		CRS	2
		NE	2
		BNC	2
4504	Martellina o cremonese con impugnatura a maniglia su nuova placca rettangolare Window Handle: 7mm square spindle or mechanism	OCR	2
		CRS	2
		NE	2
		BNC	2

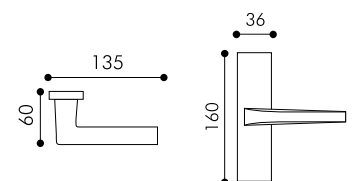
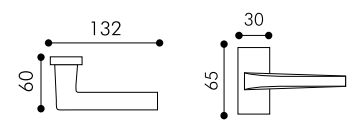
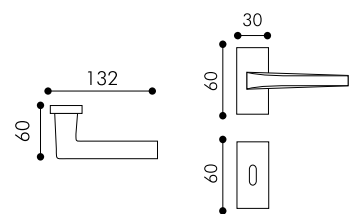
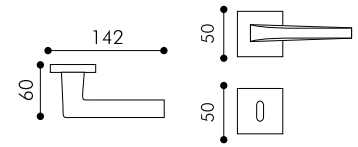

RING





OCR
CROMO LUCIDO
POLISHED CHROME

CRS
CROMO SATINATO
SATIN CHROME

OCR/CRS
BICOLOR CROMO LUC/SAT
POLISHED/SATIN CHROME



CODICE	DESCRIZIONE	FINITURE	IMBALLO
4600	Guarnitura con molla di ritorno su placche Pair spring handles. Plate	OCR	1
		CRS	1
		OCR/CRS	1
4601	Guarnitura con molla di ritorno su rosette coprivite Pair spring handles. Roses. Screw cover	OCR	1
		CRS	1
		OCR/CRS	1
4601/R	Guarnitura su rosetta ovale con molla di ritorno. Pair spring handles. Oval rose	OCR	1
		CRS	1
		OCR/CRS	1
4602	Maniglia movimento DK Handle DK movement	OCR	2
		CRS	2
		OCR/CRS	2
4604	Martellina o cremonese con impugnatura a maniglia Window Handle: 7mm square spindle or mechanism	OCR	2
		CRS	2
		OCR/CRS	2

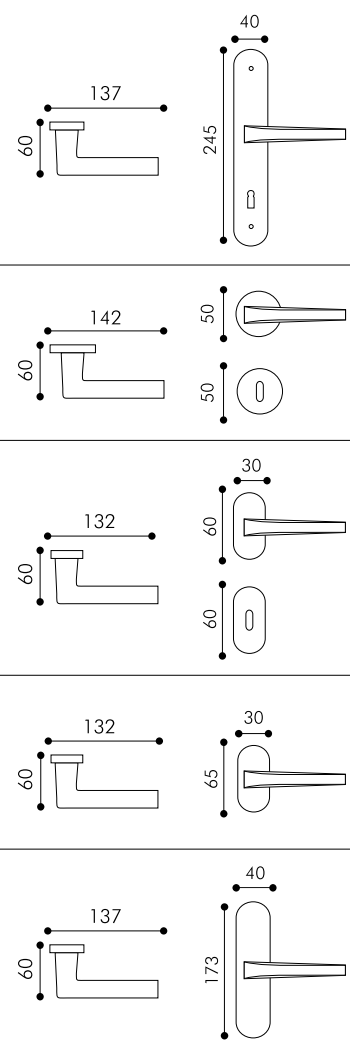

AREA 51

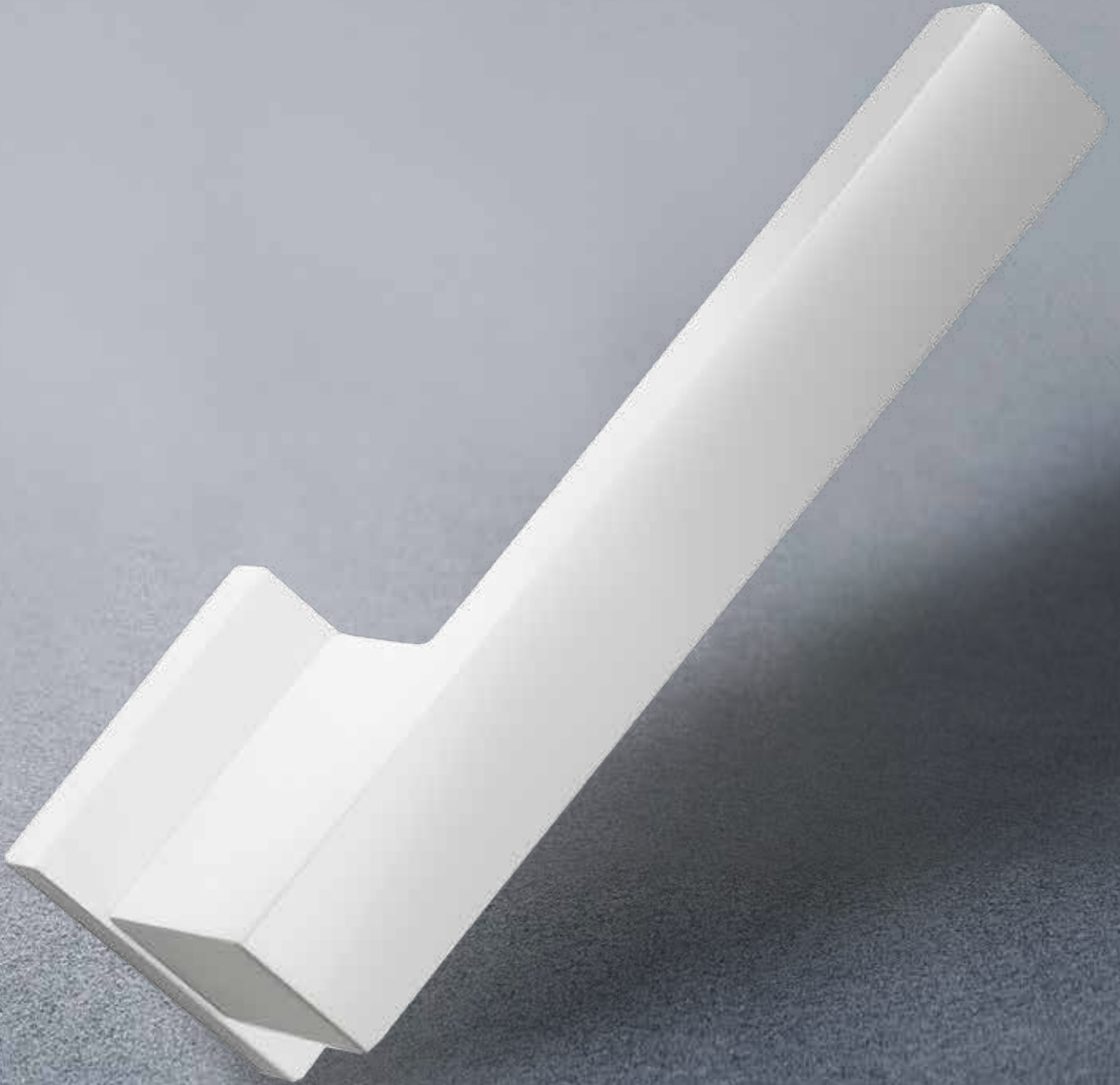



OCR
CROMO LUCIDO
POLISHED CHROME



ECRS
EFFETTO CROMO SATINATO
SATIN CHROME EFFECT



NE
NERO
BLACK



BNC
BIANCO
WHITE



CODICE	DESCRIZIONE	FINITURE	IMBALLO
9081	Guarnitura con molla di ritorno su rosette coprivite Pair spring handles. Roses. Screw cover	OCR	1
		ECRS	1
		NE	1
		BNC	1
9082	Maniglia movimento DK Handle DK movement	OCR	2
		ECRS	2
		NE	2
		BNC	2

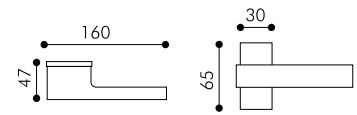
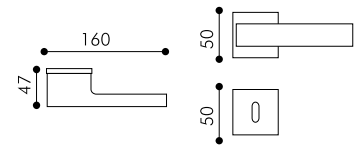

DEA





PVD
OTTONE LUCIDO PVD
PVD POLISHED BRASS



OCR
CROMO LUCIDO
POLISHED CHROME



CRS
CROMO SATINATO
SATIN CHROME



OBM
BRONZO GRAFFIATO OPACO
BRONZE YESTER



CODICE	DESCRIZIONE	FINITURE	IMBALLO
2201	Guarnitura con molla di ritorno su rosette coprivite Pair spring handles. Roses. Screw cover	PVD	1
		OCR	1
		CRS	1
		OBM	1
2202	Maniglia movimento DK Handle DK movement	PVD	1
		OCR	1
		CRS	1
		OBM	1
2203	Martellina o cremonese su placca Window Handle: 7mm square spindle or mechanism on plate	PVD	2
		OCR	2
		CRS	2
		OBM	2
2203/F	Martellina o cremonese su placca con fori a vista Window Handle: 7mm square spindle or mechanism on plate with holes	PVD	2
		OCR	2
		CRS	2
		OBM	2

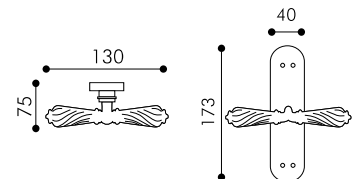
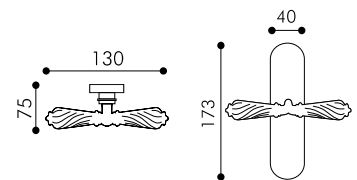
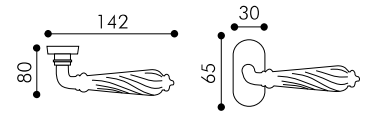
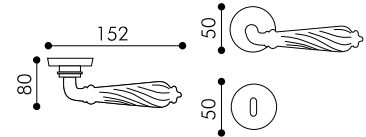

Q-CINQUE

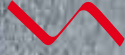



OCR
CROMO LUCIDO
POLISHED CHROME



ECRS
EFFETTO CROMO SATINATO
SATIN CHROME EFFECT



CODICE	DESCRIZIONE	FINITURE	IMBALLO
9031	Guarnitura con molla di ritorno su rosette coprivite		
	Pair spring handles. Roses. Screw cover	OCR ECRS	1 1
9032	Maniglia movimento DK		
	Handle DK movement	OCR ECRS	2 2
9034	Martellina o cremonese con impugnatura a maniglia su nuova placca rettangolare		
	Window Handle: 7mm square spindle or mechanism	OCR ECRS	1 1

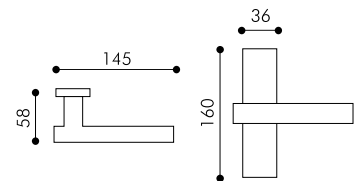
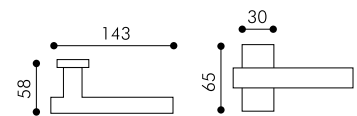
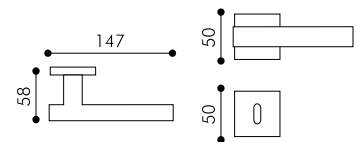

OMEGA



MODELLO DEPOSITATO - REGISTERED MODEL



CRS
CROMO SATINATO
SATIN CHROME

OCR/CRS
BICOLOR CROMO LUC/SAT
POLISHED/SATIN CHROME



CODICE	DESCRIZIONE	FINITURE	IMBALLO	
2801	Guarnitura con molla di ritorno su rosette coprivite Pair spring handles. Roses. Screw cover	CRS OCR/CRS	1 1	
2801/R	Guarnitura su rosetta ovale con molla di ritorno. Pair spring handles. Oval rose	CRS OCR/CRS	1 1	
2802	Maniglia movimento DK Handle DK movement	CRS OCR/CRS	2 2	
2804	Martellina o cremonese con impugnatura a maniglia Window Handle: 7mm square spindle or mechanism	CRS OCR/CRS	2 2	



SIRIO

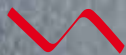



CRS
CROMO SATINATO
SATIN CHROME

OCR/CRS
BICOLOR CROMO LUC/SAT
POLISHED/SATIN CHROME



CODICE	DESCRIZIONE	FINITURE	IMBALLO
9051	Guarnitura con molla di ritorno su rosette coprivite	CRS	1
	Pair spring handles. Roses. Screw cover	OCR/CRS	1
9051/R	Guarnitura su rosetta rettangolare con molla di ritorno.	CRS	1
	Pair spring handles. Rectangular rose	OCR/CRS	1
9052	Maniglia movimento DK	CRS	2
	Handle DK movement	OCR/CRS	2
9054	Martellina o cremonese con impugnatura a maniglia su nuova placca rettangolare	CRS	1
	Window Handle: 7mm square spindle or mechanism	OCR/CRS	1



PIPITA





OCR
CROMO LUCIDO
POLISHED CHROME

CRS
CROMO SATINATO
SATIN CHROME

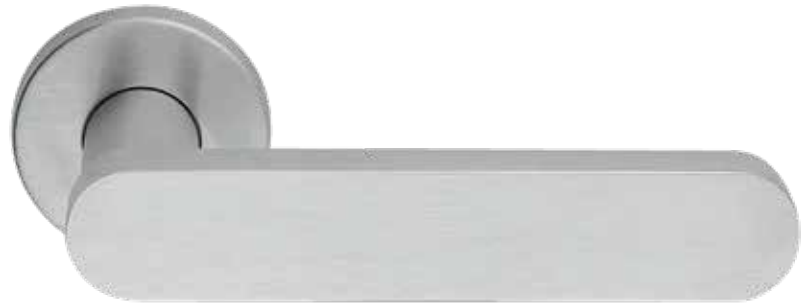

CODICE	DESCRIZIONE	FINITURE	IMBALLO	
9020	Guarnitura con molla di ritorno su placche Pair spring handles. Plate	OCR CRS	1 1	
9021	Guarnitura con molla di ritorno su rosette coprivite ø 50 mm Pair spring handles. Roses. Screw cover ø 50 mm	OCR CRS	1 1	
9022	Maniglia movimento DK Handle DK movement	OCR CRS	2 2	
9024	Martellina o cremonese con impugnatura a maniglia Window Handle: 7mm square spindle or mechanism	OCR CRS	1 1	



PIEGO





OLV
OTTONE LUCIDO VERNICIATO
POLISHED AND PAINTED BRASS



CRS
CROMO SATINATO
SATIN CHROME



OCR/CRS
BICOLOR CROMO LUC/SAT
POLISHED/SATIN CHROME



CODICE	DESCRIZIONE	FINITURE	IMBALLO
4901	Guarnitura con molla di ritorno su rosette coprivite	OLV	1
	Pair spring handles. Roses.	CRS	1
	Screw cover	OCR/CRS	1
4902	Maniglia movimento DK	OLV	1
	Handle DK movement	CRS	1
		OCR/CRS	1
4904	Martellina o cremonese con impugnatura a maniglia su nuova placca rettangolare	OLV	2
	Window Handle: 7mm square spindle or mechanism	CRS	2
		OCR/CRS	2



PRIMA





OLV
OTTONE LUCIDO VERNICIATO
POLISHED AND PAINTED BRASS



OCR
CROMO LUCIDO
POLISHED CHROME



CRS
CROMO SATINATO
SATIN CHROME



CODICE	DESCRIZIONE	FINITURE	IMBALLO
3400	Guarnitura con molla di ritorno su placche Pair spring handles. Plate	OLV OCR CRS	1 1 1
3401	Guarnitura con molla di ritorno su rosette coprivite Pair spring handles. Roses. Screw cover	OLV OCR CRS	1 1 1
3402	Maniglia movimento DK Handle DK movement	OLV OCR CRS	2 2 2
3404	Martellina o cremonese con impugnatura a maniglia Window Handle: 7mm square spindle or mechanism	OLV OCR CRS	2 2 2



QUADRA





OCR
CROMO LUCIDO
POLISHED CHROME



CRS
CROMO SATINATO
SATIN CHROME



OBM
BRONZO GRAFFIATO OPACO
BRONZE YESTER



NKS
NIKEL SATINATO
SATIN NIKEL



CODICE	DESCRIZIONE	FINITURE	IMBALLO
9061	Guarnitura con molla di ritorno su rosette coprivite Pair spring handles. Roses. Screw cover	OCR	1
		CRS	1
		OBM	1
		NKS	1
9061/R	Guarnitura su rosetta rettangolare con molla di ritorno. Pair spring handles. Rectangular rose	OCR	1
		CRS	1
		OBM	1
		NKS	1
9062	Maniglia movimento DK Handle DK movement	OCR	2
		CRS	2
		OBM	2
		NKS	2
9064	Martellina o cremonese con impugnatura a maniglia su nuova placca rettangolare Window Handle: 7mm square spindle or mechanism	OCR	2
		CRS	2
		OBM	2
		NKS	2

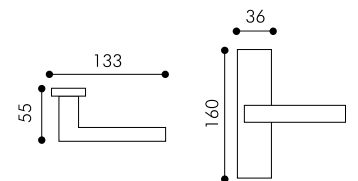
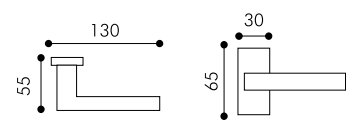
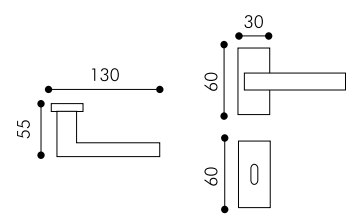
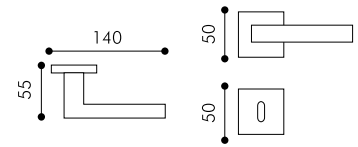

BOEMIA

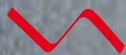



OCR
CROMO LUCIDO
POLISHED CHROME

CRS
CROMO SATINATO
SATIN CHROME

OCR/CRS
BICOLOR CROMO LUC/SAT
POLISHED/SATIN CHROME



Crystal White

CODICE	DESCRIZIONE	FINITURE	IMBALLO
2301	Guarnitura con molla di ritorno su rosette coprivite	OCR	1
	Pair spring handles. Roses. Screw cover	CRS	1
		OCR/CRS	1
2302	Maniglia movimento DK	OCR	1
	Handle DK movement	CRS	1
		OCR/CRS	1
2304	Martellina o cremonese con impugnatura a maniglia su nuova placca rettangolare	OCR	1
	Window Handle: 7mm square spindle or mechanism	CRS	1
		OCR/CRS	1

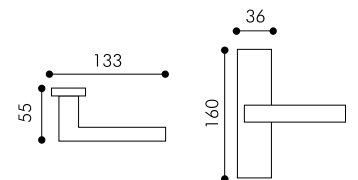
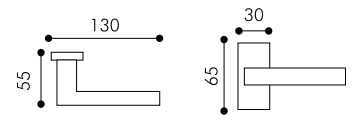
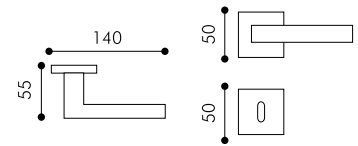

PREZIOSA





OCR-D
CROMO LUCIDO
POLISHED CHROME



CRS-D
CROMO SATINATO
SATIN CHROME



OCR-A
CROMO LUCIDO
POLISHED CHROME



CRS-A
CROMO SATINATO
SATIN CHROME



Cristal White



Acqua Marina

CODICE	DESCRIZIONE	FINITURE	IMBALLO
2401	Guarnitura con molla di ritorno su rosette coprivite Pair spring handles. Roses. Screw cover	OCR-D	1
		OCR-A	1
		CRS-D	1
		CRS-A	1
2402	Maniglia movimento DK Handle DK movement	OCR-D	1
		OCR-A	1
		CRS-D	1
		CRS-A	1
2404	Martellina o cremonese con impugnatura a maniglia su nuova placca rettangolare Window Handle: 7mm square spindle or mechanism	OCR-D	1
		OCR-A	1
		CRS-D	1
		CRS-A	1

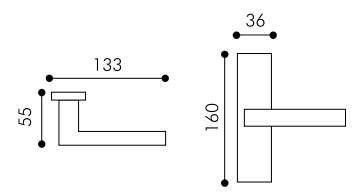
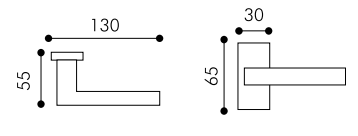
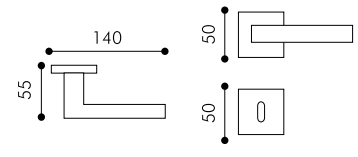

QUADRA SPORT





OCR
CROMO LUCIDO
POLISHED CHROME

CRS
CROMO SATINATO
SATIN CHROME

OCR/CRS
BICOLOR CROMO LUC/SAT
POLISHED/SATIN CHROME

OCR/CRS 2
BICOLOR CROMO LUC/SAT
POLISHED/SATIN CHROME

NE
NERO
BLACK

BNC
BIANCO
WHITE



CODICE	DESCRIZIONE	FINITURE	IMBALLO	
8091	Guarnitura con molla di ritorno su rosette coprivite Pair spring handles. Roses. Screw cover	OCR	1	
		CRS	1	
		OCR/CRS	1	
		OCR/CRS 2	1	
		NE	1	
		BNC	1	
8091/R	Guarnitura su rosetta rettangolare con molla di ritorno. Pair spring handles. Rectangular rose	OCR	1	
		CRS	1	
		OCR/CRS	1	
		OCR/CRS 2	1	
		NE	1	
		BNC	1	
8092	Maniglia movimento DK Handle DK movement	OCR	2	
		CRS	2	
		OCR/CRS	2	
		OCR/CRS 2	2	
		NE	2	
		BNC	2	
8094	Martellina o cremonese con impugnatura a maniglia su nuova placca rettangolare Window Handle: 7mm square spindle or mechanism	OCR	2	
		CRS	2	
		OCR/CRS	2	
		OCR/CRS 2	2	
		NE	2	
		BNC	2	



BELLA

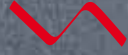

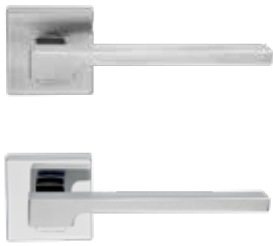

CRS
CROMO SATINATO
SATIN CHROME

OCR/CRS
BICOLOR CROMO LUC/SAT
POLISHED/SATIN CHROME



CODICE	DESCRIZIONE	FINITURE	IMBALLO	
2701	Guarnitura con molla di ritorno su rosette coprivite	CRS	1	
	Pair spring handles. Roses. Screw cover	OCR/CRS	1	
2701/R	Guarnitura su rosetta rettangolare con molla di ritorno.	CRS	1	
	Pair spring handles. Rectangular rose	OCR/CRS	1	
2702	Maniglia movimento DK	CRS	2	
	Handle DK movement	OCR/CRS	2	
2704	Martellina o cremonese con impugnatura a maniglia su nuova placca rettangolare	CRS	2	
	Window Handle: 7mm square spindle or mechanism	OCR/CRS	2	

BELLA

OTTONE - BRASS



GAIA





OCR
CROMO LUCIDO
POLISHED CHROME

CRS
CROMO SATINATO
SATIN CHROME



CODICE	DESCRIZIONE	FINITURE	IMBALLO	
3100	Guarnitura con molla di ritorno su placche Pair spring handles. Plate	OCR CRS	1 1	
3101	Guarnitura con molla di ritorno su rosette coprivite Pair spring handles. Roses. Screw cover	OCR CRS	1 1	
3102	Maniglia movimento DK Handle DK movement	OCR CRS	2 2	
3104	Martellina o cremonese con impugnatura a maniglia Window Handle: 7mm square spindle or mechanism	OCR CRS	2 2	



OPERA





OLV
OTTONE LUCIDO VERNICIATO
POLISHED AND PAINTED BRASS



OCR
CROMO LUCIDO
POLISHED CHROME



CRS
CROMO SATINATO
SATIN CHROME



OBM
BRONZO GRAFFIATO OPACO
BRONZE YESTER



CODICE	DESCRIZIONE	FINITURE	IMBALLO
4061	Guarnitura con molla di ritorno su rosette coprivite Pair spring handles. Roses. Screw cover	OLV	1
		OCR	1
		CRS	1
		OBM	1
4061/R	Guarnitura su rosetta rettangolare con molla di ritorno. Pair spring handles. Rectangular rose	OLV	1
		OCR	1
		CRS	1
		OBM	1
4062	Maniglia movimento DK Handle DK movement	OLV	2
		OCR	2
		CRS	2
		OBM	2
4064	Martellina o cremonese con impugnatura a maniglia su nuova placca rettangolare Window Handle: 7mm square spindle or mechanism	OLV	2
		OCR	2
		CRS	2
		OBM	2

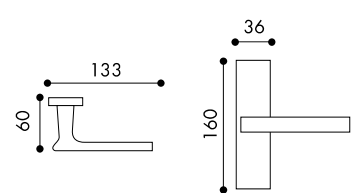
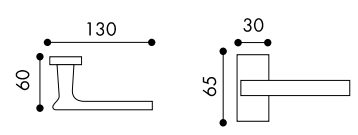
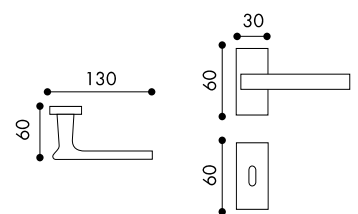
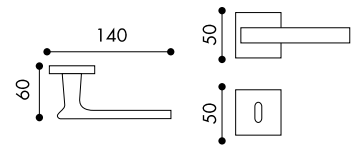

DIAMANTE



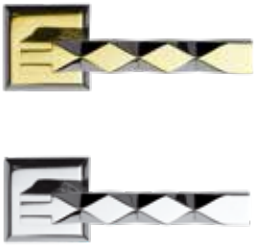

OLV
OTTONE LUCIDO VERNICIATO
POLISHED AND PAINTED BRASS

OCR
CROMO LUCIDO
POLISHED CHROME

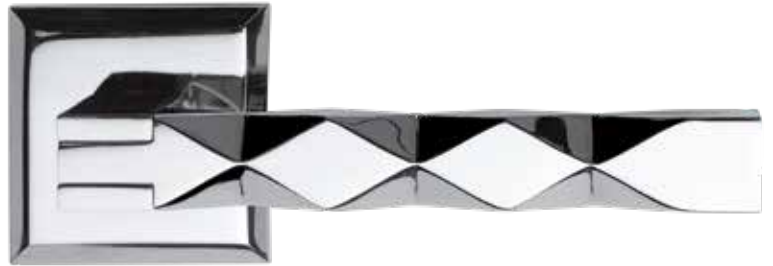

CODICE	DESCRIZIONE	FINITURE	IMBALLO
9901	Guarnitura con molla di ritorno su rosette coprivite	OLV	1
	Pair spring handles. Roses. Screw cover	OCR	1
9902	Maniglia movimento DK	OLV	2
	Handle DK movement	OCR	2
9904	Martellina o cremonese con impugnatura a maniglia su nuova placca rettangolare	OLV	1
	Window Handle: 7mm square spindle or mechanism	OCR	1

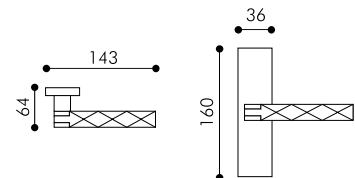
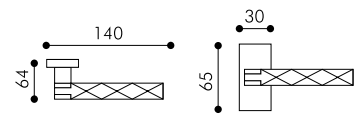
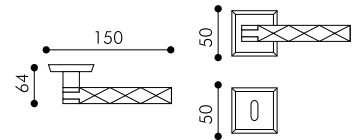

MIZAR





OLV
OTTONE LUCIDO VERNICIATO
POLISHED AND PAINTED BRASS



CRS
CROMO SATINATO
SATIN CHROME



OLV/OSL
BICOLOR OTTONE LUC/SAT
POLISHED/SATIN BRASS



OCR/CRS
BICOLOR CROMO LUC/SAT
POLISHED/SATIN CHROME



CODICE	DESCRIZIONE	FINITURE	IMBALLO
7040	Guarnitura con molla di ritorno su placche Pair spring handles. Plate	OLV	1
		CRS	1
		OLV/OSL	1
		OCR/CRS	1
7041/C	Guarnitura con molla di ritorno su rosette coprivite ø 50 mm a vitare bombate Pair spring handles. Roses. Screw cover ø 50 mm	OLV	1
		CRS	1
		OLV/OSL	1
		OCR/CRS	1
7042	Maniglia movimento DK Handle DK movement	OLV	2
		CRS	2
		OLV/OSL	2
		OCR/CRS	2
7044	Martellina o cremonese con impugnatura a maniglia Window Handle: 7mm square spindle or mechanism	OLV	2
		CRS	2
		OLV/OSL	2
		OCR/CRS	2

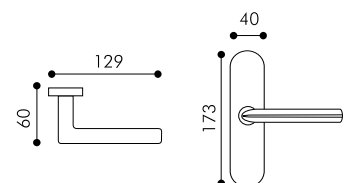
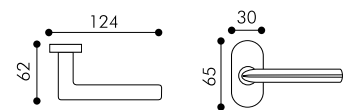
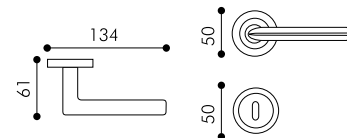
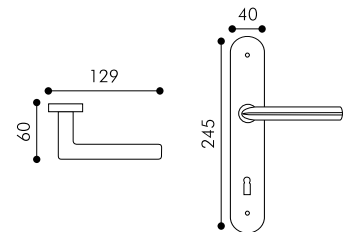

PEGASO

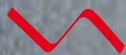



OCR
CROMO LUCIDO
POLISHED CHROME

CRS
CROMO SATINATO
SATIN CHROME



CODICE	DESCRIZIONE	FINITURE	IMBALLO	
7091	Guarnitura con molla di ritorno su rosette coprivite Pair spring handles. Roses. Screw cover	OCR CRS	1 1	
7091/R	Guarnitura su rosetta rettangolare con molla di ritorno. Pair spring handles. Rectangular rose	OCR CRS	1 1	
7092	Maniglia movimento DK Handle DK movement	OCR CRS	2 2	
7094	Martellina o cremonese con impugnatura a maniglia su nuova placca rettangolare Window Handle: 7mm square spindle or mechanism	OCR CRS	2 2	



SMART





ROSETTA DA:
50x50 mm

OCR
CROMO LUCIDO
POLISHED CHROME

CRS
CROMO SATINATO
SATIN CHROME

ROSETTA DA:
45x45 mm

OCR
CROMO LUCIDO
POLISHED CHROME

CRS
CROMO SATINATO
SATIN CHROME



CODICE	DESCRIZIONE	FINITURE	IMBALLO
6080	Guarnitura con molla di ritorno su placche Pair spring handles. Plate	OCR CRS	1 1
6081/50	Guarnitura con molla di ritorno su rosette coprivite Pair spring handles. Roses. Screw cover	OCR CRS	2 2
6081/45	Guarnitura con molla di ritorno su rosette coprivite Pair spring handles. Roses. Screw cover	OCR CRS	1 1
6081/R	Guarnitura su rosetta rettangolare con molla di ritorno. Pair spring handles. Rectangular rose	OCR CRS	2 2
6082	Maniglia movimento DK Handle DK movement	OCR CRS	4 4
6084	Martellina o cremonese con impugnatura a maniglia su nuova placca rettangolare Window Handle: 7mm square spindle or mechanism	OCR CRS	2 2



MAREA





OLV
OTTONE LUCIDO VERNICIATO
POLISHED AND PAINTED BRASS



OCR
CROMO LUCIDO
POLISHED CHROME



CRS
CROMO SATINATO
SATIN CHROME



OCR/CRS
BICOLOR CROMO LUC/SAT
POLISHED/SATIN CHROME



OBG
BRONZO GRAFFIATO LUCIDO
SCRATCHED POLISHED BRONZE



CODICE	DESCRIZIONE	FINITURE	IMBALLO
8030	Guarnitura con molla di ritorno su placche Pair spring handles. Plate	OLV	1
		OCR	1
		CRS	1
		OCR/CRS	1
		OBG	1
8031	Guarnitura con molla di ritorno su rosette coprivite Pair spring handles. Roses. Screw cover	OLV	2
		OCR	2
		CRS	2
		OCR/CRS	2
		OBG	2
8032	Maniglia movimento DK Handle DK movement	OLV	4
		OCR	4
		CRS	4
		OCR/CRS	4
		OBG	4



PRESSBURG





OLV
OTTONE LUCIDO VERNICIATO
POLISHED AND PAINTED BRASS



OCR
CROMO LUCIDO
POLISHED CHROME



CRS
CROMO SATINATO
SATIN CHROME



OBG
BRONZO GRAFFIATO LUCIDO
SCRATCHED POLISHED BRONZE



CODICE	DESCRIZIONE	FINITURE	IMBALLO
5070	Guarnitura con molla di ritorno su placche Pair spring handles. Plate	OLV	1
		OCR	1
		CRS	1
		OBG	1
5071	Guarnitura con molla di ritorno su rosette coprivite Pair spring handles. Roses. Screw cover	OLV	1
		OCR	1
		CRS	1
		OBG	1
5072	Maniglia movimento DK Handle DK movement	OLV	2
		OCR	2
		CRS	2
		OBG	2
5073/F	Martellina o cremonese su placca con fori in vista Window Handle: 7mm square spindle or mechanism on plate with holes	OLV	2
		OCR	2
		CRS	2
		OBG	2

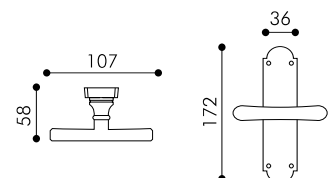
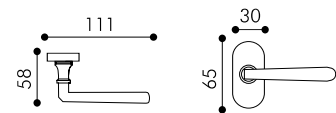
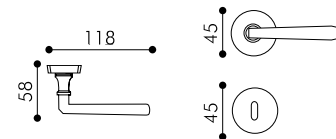
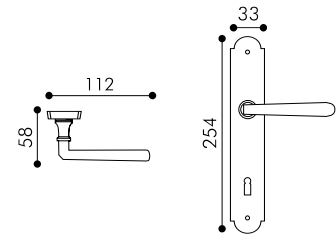

CLASSIC





OLV
OTTONE LUCIDO VERNICIATO
POLISHED AND PAINTED BRASS



OCR
CROMO LUCIDO
POLISHED CHROME



CRS
CROMO SATINATO
SATIN CHROME



OBG
BRONZO GRAFFIATO LUCIDO
SCRATCHED POLISHED BRONZE



CODICE	DESCRIZIONE	FINITURE	IMBALLO
1860	Guarnitura con molla di ritorno su placche Pair spring handles. Plate	OLV	1
		OCR	1
		CRS	1
		OBG	1
1861	Guarnitura con molla di ritorno su rosette coprivite Pair spring handles. Roses. Screw cover	OLV	2
		OCR	2
		CRS	2
		OBG	2
1862	Maniglia movimento DK Handle DK movement	OLV	2
		OCR	2
		CRS	2
		OBG	2
1863	Martellina o cremonese su placca Window Handle: 7mm square spindle or mechanism on plate	OLV	2
		OCR	2
		CRS	2
		OBG	2

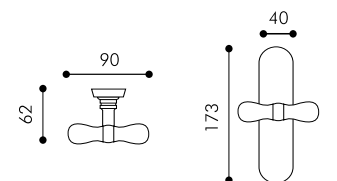
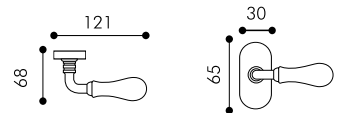
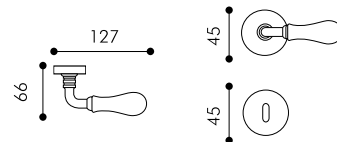
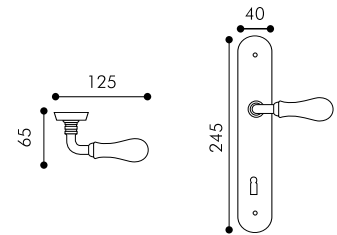

CASTEL





OLV
OTTONE LUCIDO VERNICIATO
POLISHED AND PAINTED BRASS



ANT
BRONZO ANTICO OPACO
ANTIQU BRONZE



NA
NIKEL NERO FERROANTICO
ANTIQU SILVER



CODICE	DESCRIZIONE	FINITURE	IMBALLO
1150	Guarnitura con molla di ritorno su placche Pair spring handles. Plate	OLV ANT NA	1 1 1
1151	Guarnitura con molla di ritorno su rosette coprivate Pair spring handles. Roses. Screw cover	OLV ANT NA	1 1 1
1152	Maniglia movimento DK Handle DK movement	OLV ANT NA	2 2 2
1154	Martellina o cremonese con impugnatura a maniglia Window Handle: 7mm square spindle or mechanism	OLV ANT NA	2 2 2



MIRADUE

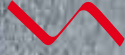



OLV
OTTONE LUCIDO VERNICIATO
POLISHED AND PAINTED BRASS



CRS
CROMO SATINATO
SATIN CHROME



OBG
BRONZO GRAFFIATO LUCIDO
SCRATCHED POLISHED BRONZE



NE
NERO
BLACK



BNC
BIANCO
WHITE

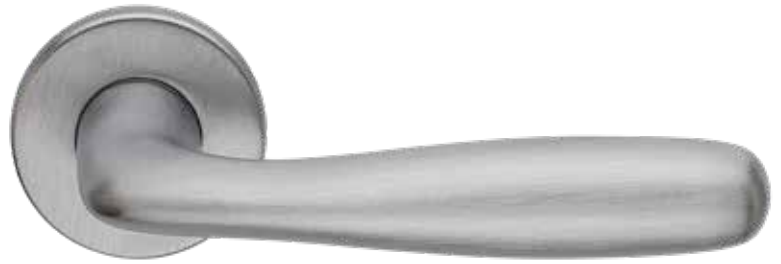

CODICE	DESCRIZIONE	FINITURE	IMBALLO
5090	Guarnitura con molla di ritorno su placche Pair spring handles. Plate	OLV CRS OBG	1 1 1
5091	Guarnitura con molla di ritorno su rosette coprivite Pair spring handles. Roses. Screw cover	OLV CRS OBG NE BNC	1 1 1 1 1
5092	Maniglia movimento DK Handle DK movement	OLV CRS OBG NE BNC	2 2 2 2 2

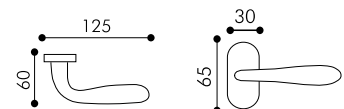
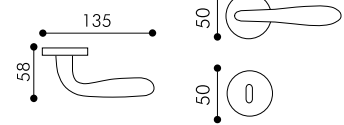
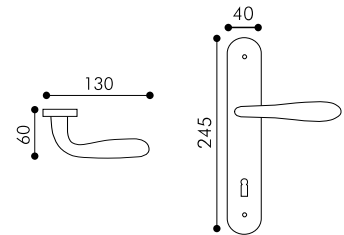

MERAK





OLV
OTTONE LUCIDO VERNICIATO
POLISHED AND PAINTED BRASS



OCR
CROMO LUCIDO
POLISHED CHROME



CRS
CROMO SATINATO
SATIN CHROME



OBG
BRONZO GRAFFIATO LUCIDO
SCRATCHED POLISHED BRONZE

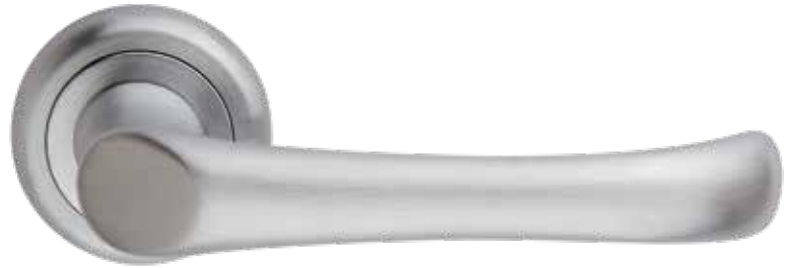

CODICE	DESCRIZIONE	FINITURE	IMBALLO
5010	Guarnitura con molla di ritorno su placche Pair spring handles. Plate	OLV	1
		OCR	1
		CRS	1
		OBG	1
5011	Guarnitura con molla di ritorno su rosette coprivite Pair spring handles. Roses. Screw cover	OLV	1
		OCR	1
		CRS	1
		OBG	1
5012	Maniglia movimento DK Handle DK movement	OLV	2
		OCR	2
		CRS	2
		OBG	2
5014	Martellina o cremonese con impugnatura a maniglia Window Handle: 7mm square spindle or mechanism	OLV	2
		OCR	2
		CRS	2
		OBG	2

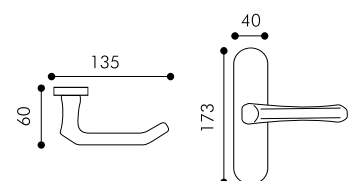
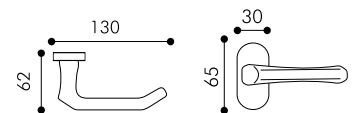
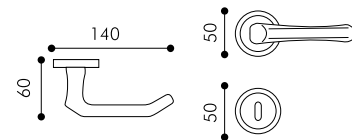
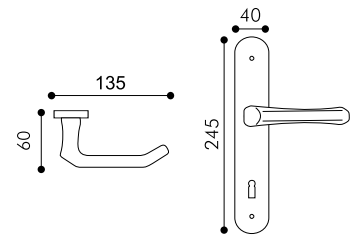

SPIRIT





OLV
OTTONE LUCIDO VERNICIATO
POLISHED AND PAINTED BRASS



CRS
CROMO SATINATO
SATIN CHROME



OLV/OSL
BICOLOR OTTONE LUC/SAT
POLISHED/SATIN BRASS



OCR/CRS
BICOLOR CROMO LUC/SAT
POLISHED/SATIN CHROME



CODICE	DESCRIZIONE	FINITURE	IMBALLO
7030	Guarnitura con molla di ritorno su placche Lusso Pair spring handles. Plate	OLV	1
		CRS	1
		OLV/OSL	1
		OCR/CRS	1
7031	Guarnitura con molla di ritorno su rosette coprivate ø 50 mm a vitare bombate Pair spring handles. Roses Screw cover ø 50 mm	OLV	1
		CRS	1
		OLV/OSL	1
		OCR/CRS	1
7032	Maniglia movimento DK Handle DK movement	OLV	2
		CRS	2
		OLV/OSL	2
		OCR/CRS	2
7034	Martellina o cremonese con impugnatura a maniglia Window Handle: 7mm square spindle or mechanism	OLV	2
		CRS	2
		OLV/OSL	2
		OCR/CRS	2

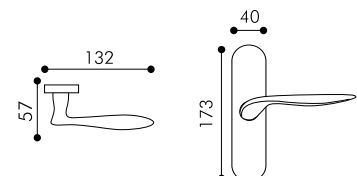
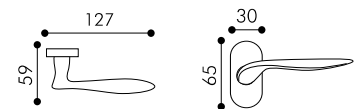
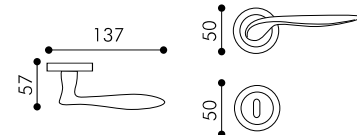
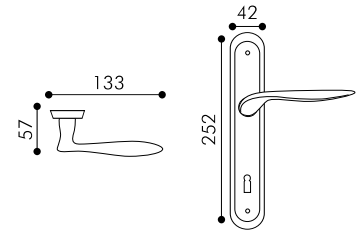

GRETA





OLV
OTTONE LUCIDO VERNICIATO
POLISHED AND PAINTED BRASS



OCR
CROMO LUCIDO
POLISHED CHROME



CRS
CROMO SATINATO
SATIN CHROME



OBG
BRONZO GRAFFIATO LUCIDO
SCRATCHED POLISHED BRONZE



CODICE	DESCRIZIONE	FINITURE	IMBALLO
7080	Guarnitura con molla di ritorno su placche Pair spring handles. Plate	OLV	1
		OCR	1
		CRS	1
		OBG	1
7081	Guarnitura con molla di ritorno su rosette coprivite Pair spring handles. Roses. Screw cover	OLV	2
		OCR	2
		CRS	2
		OBG	2
7082	Maniglia movimento DK Handle DK movement	OLV	4
		OCR	4
		CRS	2
		OBG	2
7084	Martellina o cremonese con impugnatura a maniglia Window Handle: 7mm square spindle or mechanism	OLV	2
		OCR	2
		CRS	2
		OBG	2

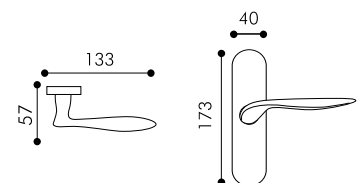
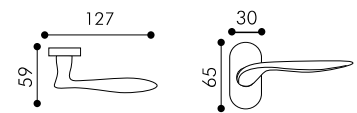
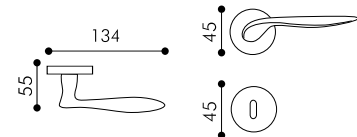
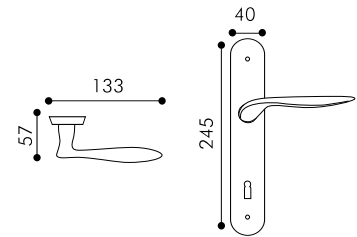

ALTAIR

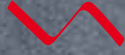



OLV
OTTONE LUCIDO VERNICIATO
POLISHED AND PAINTED BRASS



CRS
CROMO SATINATO
SATIN CHROME



OCR/CRS
BICOLOR CROMO LUC/SAT
POLISHED/SATIN CHROME



OBG
BRONZO GRAFFIATO LUCIDO
SCRATCHED POLISHED BRONZE



CODICE	DESCRIZIONE	FINITURE	IMBALLO	
5030	Guarnitura con molla di ritorno su placche Pair spring handles. Plate	OLV CRS OBG	1 1 1	
5031	Guarnitura con molla di ritorno su rosette coprivite Pair spring handles. Roses. Screw cover	OLV CRS OCR/CRS OBG	1 1 1 1	
5032	Maniglia movimento DK Handle DK movement	OLV CRS OCR/CRS OBG	2 2 2 2	
5034	Martellina o cremonese con impugnatura a maniglia Window Handle: 7mm square spindle or mechanism	OLV CRS OBG	2 2 2	



MODERNA

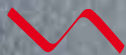



OCR
CROMO LUCIDO
POLISHED CHROME



CRS
CROMO SATINATO
SATIN CHROME



CODICE	DESCRIZIONE	FINITURE	IMBALLO
3301	Guarnitura con molla di ritorno su rosette coprivite Pair spring handles. Roses. Screw cover	OCR	1
		CRS	1
3301/R	Guarnitura su rosetta rettangolare con molla di ritorno. Pair spring handles. Rectangular rose	OCR	1
		CRS	1
3302	Maniglia movimento DK Handle DK movement	OCR	2
		CRS	2
3304	Martellina o cremonese con impugnatura a maniglia su nuova placca rettangolare Window Handle: 7mm square spindle or mechanism	OCR	2
		CRS	2

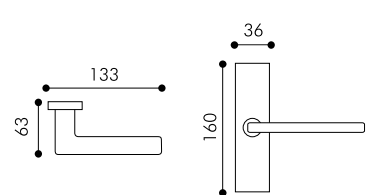
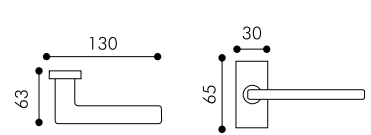
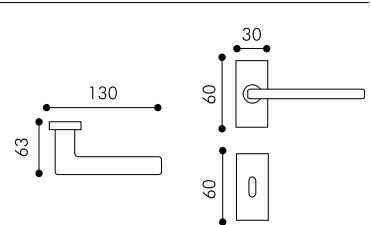
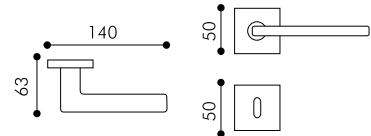

SOLE





PVD
OTTONE LUCIDO PVD
PVD POLISHED BRASS



OLV
OTTONE LUCIDO VERNICIATO
POLISHED AND PAINTED BRASS



OCR
CROMO LUCIDO
POLISHED CHROME



CRS
CROMO SATINATO
SATIN CHROME



CODICE	DESCRIZIONE	FINITURE	IMBALLO
7020	Guarnitura con molla di ritorno su placche Pair spring handles. Plate	PVD	1
		OLV	1
		OCR	1
		CRS	1
7021	Guarnitura con molla di ritorno su rosette coprivate Pair spring handles. Roses. Screw cover	PVD	1
		OLV	1
		OCR	1
		CRS	1
7022	Maniglia movimento DK Handle DK movement	PVD	2
		OLV	2
		OCR	2
		CRS	2
7024	Martellina o cremonese con impugnatura a maniglia Window Handle: 7mm square spindle or mechanism	PVD	2
		OLV	2
		OCR	2
		CRS	2

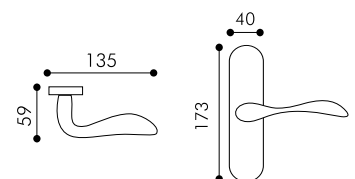
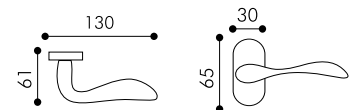
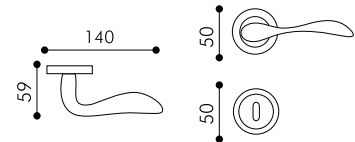
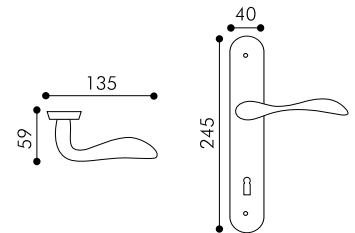

FORTUNA





OLV/OSL
BICOLOR OTTONE LUC/SAT
POLISHED/SATIN BRASS



OCR/CRS
BICOLOR CROMO LUC/SAT
POLISHED/SATIN CHROME



CODICE	DESCRIZIONE	FINITURE	IMBALLO	
6050	Guarnitura con molla di ritorno su placche Lusso Pair spring handles. Plate	OLV/OSL OCR/CRS	1 1	
6051	Guarnitura con molla di ritorno su rosette coprivite Pair spring handles. Roses. Screw cover	OLV/OSL OCR/CRS	1 1	
6052	Maniglia movimento DK Handle DK movement	OLV/OSL OCR/CRS	2 2	
6054	Martellina o cremonese con impugnatura a maniglia Window Handle: 7mm square spindle or mechanism	OLV/OSL OCR/CRS	2 2	



ONDA

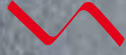



OLV
OTTONE LUCIDO VERNICIATO
POLISHED AND PAINTED BRASS



OCR
CROMO LUCIDO
POLISHED CHROME



CRS
CROMO SATINATO
SATIN CHROME



CODICE	DESCRIZIONE	FINITURE	IMBALLO
6090	Guarnitura con molla di ritorno su placche Pair spring handles. Plate	OLV OCR CRS	1 1 1
6091	Guarnitura con molla di ritorno su rosette coprivite Pair spring handles. Roses. Screw cover	OLV OCR CRS	1 1 1
6092	Maniglia movimento DK Handle DK movement	OLV OCR CRS	2 2 2
6094	Martellina o cremonese con impugnatura a maniglia Window Handle: 7mm square spindle or mechanism	OLV OCR CRS	2 2 2



ARCA





OLV/OSL
BICOLOR OTTONE LUC/SAT
POLISHED/SATIN BRASS

OCR/CRS
BICOLOR CROMO LUC/SAT
POLISHED/SATIN CHROME



CODICE	DESCRIZIONE	FINITURE	IMBALLO	
6030	Guarnitura con molla di ritorno su placche Pair spring handles. Plate	OLV/OSL OCR/CRS	1 1	
6031	Guarnitura con molla di ritorno su rosette coprivite Pair spring handles. Roses. Screw cover	OLV/OSL OCR/CRS	1 1	
6032	Maniglia movimento DK Handle DK movement	OLV/OSL OCR/CRS	2 2	
6034	Martellina o cremonese con impugnatura a maniglia Window Handle: 7mm square spindle or mechanism	OLV/OSL OCR/CRS	2 2	



POLAR





ROSETTA DA:
ø 50 mm

OLV/OSL
BICOLOR OTTONE LUC/SAT
POLISHED/SATIN BRASS



OCR/CRS
BICOLOR CROMO LUC/SAT
POLISHED/SATIN CHROME



ROSETTA DA:
ø 45 mm

OLV
OTTONE LUCIDO VERNICIATO
POLISHED AND PAINTED BRASS



CRS
CROMO SATINATO
SATIN CHROME



CODICE	DESCRIZIONE	FINITURE	IMBALLO
3000	Guarnitura con molla di ritorno su placche Pair spring handles. Plate	OLV	1
		CRS	1
		OLV/OSL	1
		OCR/CRS	1
3001	Guarnitura con molla di ritorno su rosette coprivite Pair spring handles. Roses. Screw cover	OLV/OSL	1
		OCR/CRS	1
3011	Guarnitura con molla di ritorno su rosette coprivite Pair spring handles. Roses. Screw cover	OLV	1
		CRS	1
3002	Maniglia movimento DK Handle DK movement	OLV	2
		CRS	2
		OLV/OSL	2
		OCR/CRS	2
3004	Martellina o cremonese con impugnatura a maniglia Window Handle: 7mm square spindle or mechanism	OLV	2
		CRS	2
		OLV/OSL	2
		OCR/CRS	2

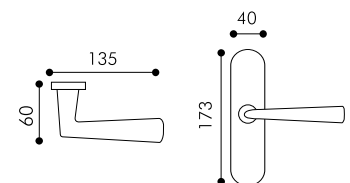
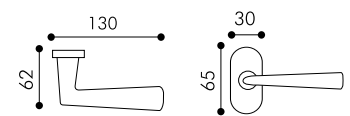
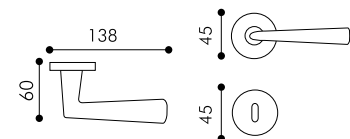
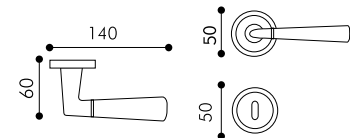
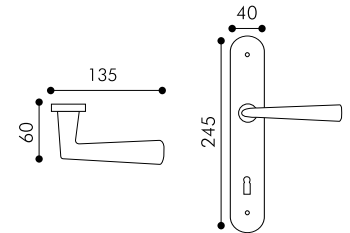

JOLLY





PVD
OTTONE LUCIDO PVD
PVD POLISHED BRASS



OLV
OTTONE LUCIDO VERNICIATO
POLISHED AND PAINTED BRASS



OCR
CROMO LUCIDO
POLISHED CHROME



CRS
CROMO SATINATO
SATIN CHROME



OBG
BRONZO GRAFFIATO LUCIDO
SCRATCHED POLISHED BRONZE



CODICE	DESCRIZIONE	FINITURE	IMBALLO
8050	Guarnitura con molla di ritorno su placche Pair spring handles. Plate	PVD	2
		OLV	2
		OCR	2
		CRS	2
		OBG	2
8051	Guarnitura con molla di ritorno su rosette coprivite Pair spring handles. Roses. Screw cover	PVD	1
		OLV	1
		OCR	1
		CRS	1
		OBG	1
8052	Maniglia movimento DK Handle DK movement	PVD	2
		OLV	2
		OCR	2
		CRS	2
		OBG	2
8054	Martellina o cremonese con impugnatura a maniglia Window Handle: 7mm square spindle or mechanism	PVD	2
		OLV	2
		OCR	2
		CRS	2
		OBG	2

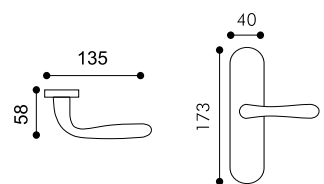
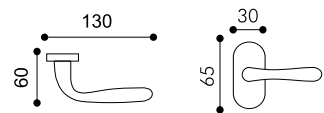
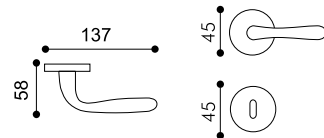
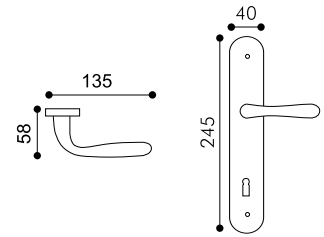

DOLLY





PVD
OTTONE LUCIDO PVD
PVD POLISHED BRASS



OLV
OTTONE LUCIDO VERNICIATO
POLISHED AND PAINTED BRASS



OCR
CROMO LUCIDO
POLISHED CHROME



CRS
CROMO SATINATO
SATIN CHROME



OSL
OTTONE SATINATO VERNICIATO
SATINED AND PAINTED BRASS



OBG
BRONZO GRAFFIATO LUCIDO
SCRATCHED POLISHED BRONZE



CODICE	DESCRIZIONE	FINITURE	IMBALLO
8040	Guarnitura con molla di ritorno su placche Pair spring handles. Plate	PVD	1
		OLV	1
		OCR	1
		CRS	2
		OSL	1
		OBG	2
8041	Guarnitura con molla di ritorno su rosette coprivite Pair spring handles. Roses. Screw cover	PVD	1
		OLV	1
		OCR	1
		CRS	1
		OSL	1
		OBG	1
8042	Maniglia movimento DK Handle DK movement	PVD	2
		OLV	2
		OCR	2
		CRS	2
		OSL	2
		OBG	2
8044	Martellina o cremonese con impugnatura a maniglia Window Handle: 7mm square spindle or mechanism	PVD	2
		OLV	2
		OCR	2
		CRS	2
		OSL	2
		OBG	2

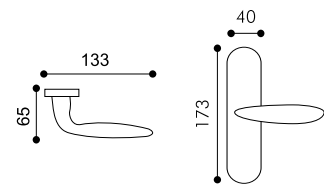
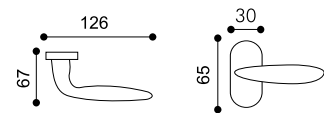
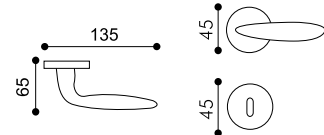
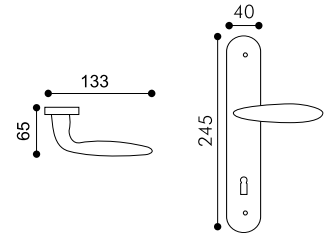

VELA





OLV
OTTONE LUCIDO VERNICIATO
POLISHED AND PAINTED BRASS



OCR
CROMO LUCIDO
POLISHED CHROME



CRS
CROMO SATINATO
SATIN CHROME



NKS
NIKEL SATINATO
SATIN NIKEL



CODICE	DESCRIZIONE	FINITURE	IMBALLO
6000	Guarnitura con molla di ritorno su placche Pair spring handles. Plate	OLV	1
		OCR	1
		CRS	1
		NKS	1
6001	Guarnitura con molla di ritorno su rosette coprivite Pair spring handles. Roses. Screw cover	OLV	1
		OCR	1
		CRS	1
		NKS	1
6002	Maniglia movimento DK Handle DK movement	OLV	2
		OCR	2
		CRS	2
		NKS	2
6004	Martellina o cremonese con impugnatura a maniglia Window Handle: 7mm square spindle or mechanism	OLV	2
		OCR	2
		CRS	2
		NKS	2

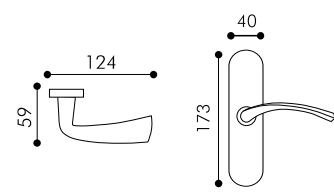
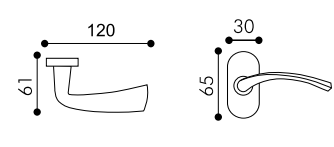
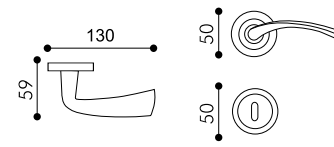
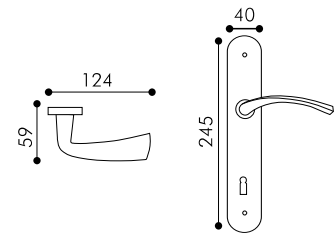

CIGNO





OLV/C
OTTONE LUCIDO VERNICIATO
PORCELLANA CHIARA
POLISHED AND PAINTED BRASS
WHITE CERAMIC



ANT/C
BRONZO ANTICO OPACO
PORCELLANA CHIARA
ANTIQUÉ BRONZE
WHITE CERAMIC



NKS/S
NIKEL SATINATO
PORCELLANA SCURA
SATIN NIKEL
DARK CERAMIC



OBG/S
BRONZO GRAFFIATO LUCIDO
PORCELLANA SCURA
SCRATCHED POLISHED BRONZE
DARK CERAMIC



CODICE	DESCRIZIONE	FINITURE	IMBALLO
7500	Guarnitura con molla di ritorno su placche	OLV/C - OLV/S	1
	Pair spring handles. Plate	ANT/C - ANT/S	1
		NKS/C - NKS/S	1
		OBG/C - OBG/S	1
7501	Guarnitura con molla di ritorno su rosette coprivate	OLV/C - OLV/S	1
	Pair spring handles. Roses. Screw cover	ANT/C - ANT/S	1
		NKS/C - NKS/S	1
		OBG/C - OBG/S	1
7502	Maniglia movimento DK	OLV/C - OLV/S	2
	Handle DK movement	ANT/C - ANT/S	2
		NKS/C - NKS/S	2
		OBG/C - OBG/S	2
7503	Martellina o cremonese su placca	OLV/C - OLV/S	2
	Window Handle: 7mm square spindle or mechanism on plate	ANT/C - ANT/S	2
		NKS/C - NKS/S	2
		OBG/C - OBG/S	2

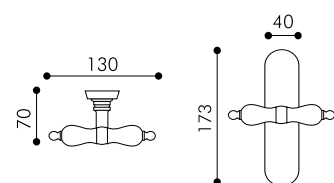
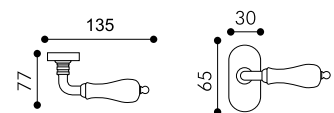
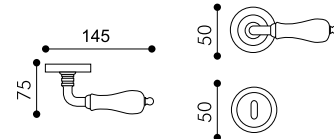
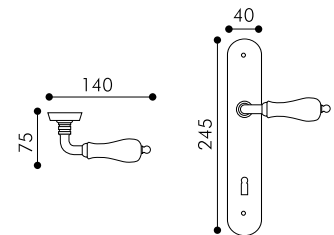

IRIS





OLV/C
OTTONE LUCIDO VERNICIATO
PORCELLANA CHIARA
POLISHED AND PAINTED BRASS
WHITE CERAMIC



ANT/C
BRONZO ANTICO OPACO
PORCELLANA CHIARA
ANTIQUÉ BRONZE
WHITE CERAMIC



OLV/S
OTTONE LUCIDO VERNICIATO
PORCELLANA SCURA
POLISHED AND PAINTED BRASS
DARK CERAMIC



ANT/S
BRONZO ANTICO OPACO
PORCELLANA SCURA
ANTIQUÉ BRONZE
DARK CERAMIC

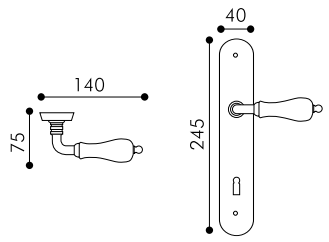
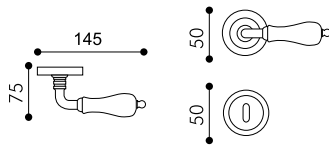
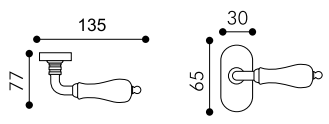
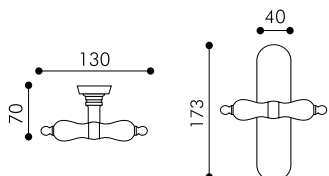

CODICE	DESCRIZIONE	FINITURE	IMBALLO
7600	Guarnitura con molla di ritorno su placche Pair spring handles. Plate	OLV/C - OLV/S ANT/C - ANT/S OBG/C - OBG/S	1 1 1 
7601	Guarnitura con molla di ritorno su rosette coprivite Pair spring handles. Roses. Screw cover	OLV/C - OLV/S ANT/C - ANT/S OBG/C - OBG/S	1 1 1 
7602	Maniglia movimento DK Handle DK movement	OLV/C - OLV/S ANT/C - ANT/S OBG/C - OBG/S	2 2 2 
7603	Martellina o cremonese su placca Window Handle: 7mm square spindle or mechanism on plate	OLV/C - OLV/S ANT/C - ANT/S OBG/C - OBG/S	2 2 2 



SCILLA





OLV
 OTTONE LUCIDO VERNICIATO
 PORCELLANA CHIARA
 POLISHED AND PAINTED BRASS
 WHITE CERAMIC



CRS
 CROMO SATINATO
 PORCELLANA CHIARA
 SATIN CHROME
 WHITE CERAMIC



CODICE	DESCRIZIONE	FINITURE	IMBALLO
7400	Guarnitura con molla di ritorno su placche Pair spring handles. Plate	OLV CRS	1 1
7401	Guarnitura con molla di ritorno su rosette coprivite Pair spring handles. Roses. Screw cover	OLV CRS	1 1
7402	Maniglia movimento DK Handle DK movement	OLV CRS	2 2
7403	Martellina o cremonese su placca Window Handle: 7mm square spindle or mechanism on plate	OLV CRS	2 2



CRAQUELÈ





OLV
OTTONE LUCIDO VERNICIATO
PORCELLANA CHIARA
POLISHED AND PAINTED BRASS
LIGHT CERAMIC



ANT
BRONZO ANTICO OPACO
PORCELLANA CHIARA
ANTIQUÉ BRONZE
LIGHT CERAMIC

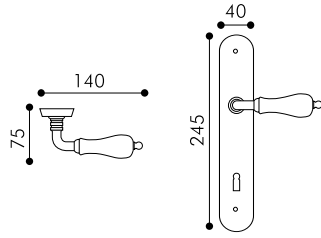
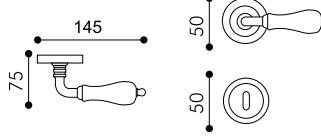
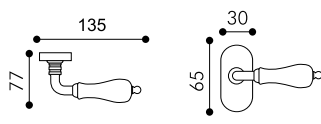
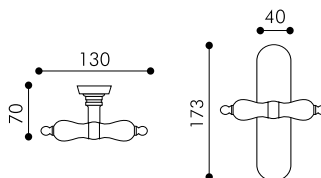

CODICE	DESCRIZIONE	FINITURE	IMBALLO
7900	Guarnitura con molla di ritorno su placche Pair spring handles. Plate	OLV ANT	1 1 
7901	Guarnitura con molla di ritorno su rosette coprivite Pair spring handles. Roses. Screw cover	OLV ANT	1 1 
7902	Maniglia movimento DK Handle DK movement	OLV ANT	2 2 
7903	Martellina o cremonese su placca Window Handle: 7mm square spindle or mechanism on plate	OLV ANT	2 2 



LINEA BASIC
BASIC LINE





**ROSETTA DA:
50x50 mm**

CRS
CROMO SATINATO
SATIN CHROME



**ROSETTA DA:
45x45 mm**

CRS
CROMO SATINATO
SATIN CHROME

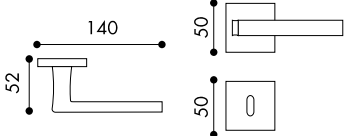
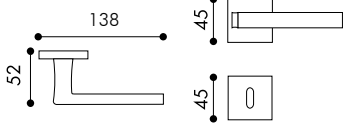
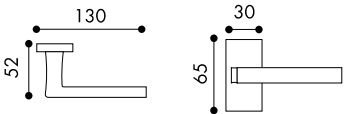

CODICE	DESCRIZIONE	FINITURE	IMBALLO	
6081/BP/50	Guarnitura con molla di ritorno su rosetta alluminio Lux 50x50 mm Pair spring handles. Roses Lux 50x50 mm	CRS	1	
6081/BP/45	Guarnitura con molla di ritorno su rosetta alluminio 45x45 mm Pair spring handles. Roses 45x45 mm	CRS	1	
6082/BP	Maniglia movimento DK in plastica Handle DK plastic movement	CRS	2	



CRS
CROMO SATINATO
SATIN CHROME



OCR/CRS
BICOLOR CROMO LUC/SAT
POLISHED/SATIN CHROME



NE
NERO
BLACK



CODICE	DESCRIZIONE	FINITURE	IMBALLO
7041	Guarnitura con molla di ritorno su rosetta alluminio	CRS	1
	Pair spring handles. Roses.	OCR/CRS	1
	Screw cover	NE	1
7042	Maniglia movimento DK	CRS	2
	Handle DK movement	OCR/CRS	2
		NE	2

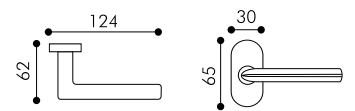
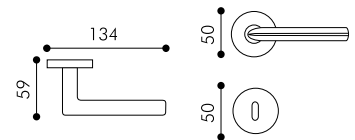

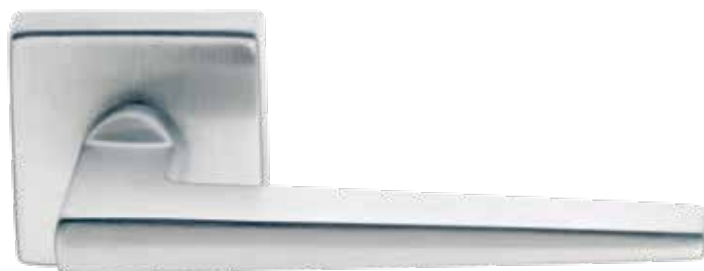

OCR
CROMO LUCIDO
POLISHED CHROME



CRS
CROMO SATINATO
SATIN CHROME

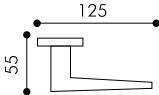
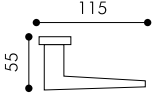
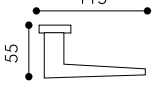
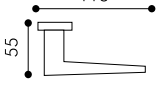

CODICE	DESCRIZIONE	FINITURE	IMBALLO	
9071	Guarnitura con molla di ritorno su rosette coprivite	OCR	1	
	Pair spring handles. Roses. Screw cover	CRS	1	
9071/R	Guarnitura su rosetta rettangolare con molla di ritorno.	OCR	1	
	Pair spring handles. Rectangular rose	CRS	1	
9072	Maniglia movimento DK	OCR	2	
	Handle DK movement	CRS	2	
9074	Martellina o cremonese con impugnatura a maniglia su nuova placca rettangolare	OCR	2	
	Window Handle: 7mm square spindle or mechanism	CRS	2	



OCR
CROMO LUCIDO
POLISHED CHROME



CRS
CROMO SATINATO
SATIN CHROME



OCR/CRS
BICOLOR CROMO LUC/SAT
POLISHED/SATIN CHROME



CODICE	DESCRIZIONE	FINITURE	IMBALLO
9097	Guarnitura con molla di ritorno su rosette coprivite	OCR	1
	Pair spring handles. Roses. Screw cover	CRS	1
		OCR/CRS	1
9092	Maniglia movimento DK	OCR	1
	Handle DK movement	CRS	1
		OCR/CRS	1
9093	Martellina o cremonese quadro su nuova placca rettangolare Window Handle: 7mm square spindle or mechanism on plate	CRS	1

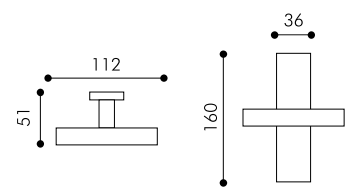
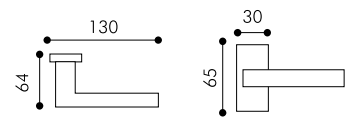
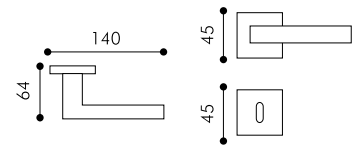



OLV
OTTONE LUCIDO VERNICIATO
POLISHED AND PAINTED BRASS

OCR
CROMO LUCIDO
POLISHED CHROME

CRS
CROMO SATINATO
SATIN CHROME

NKS
NIKEL SATINATO
SATIN NIKEL

OSL
OTTONE SATINATO VERNICIATO
SATINED AND PAINTED BRASS

OBG
BRONZO GRAFFIATO LUCIDO
SCRATCHED POLISHED BRONZE



CODICE	DESCRIZIONE	FINITURE	IMBALLO
5040	Guarnitura con molla di ritorno su placche Pair spring handles. Plate	OLV	1
		OCR	1
		CRS	1
		NKS	1
		OSL	1
		OBG	1
5041	Guarnitura con molla di ritorno su rosette coprivite Pair spring handles. Roses. Screw cover	OLV	1
		OCR	1
		CRS	1
		NKS	1
		OSL	1
		OBG	1
5042	Maniglia movimento DK Handle DK movement	OLV	2
		OCR	2
		CRS	2
		NKS	2
		OSL	2
		OBG	2
5043	Martellina o cremonese su placca senza fori in vista meccanismo intercambiabile Window Handle: 7mm square spindle or mechanism on plate	OLV	2
		OCR	2
		CRS	2
		NKS	2
		OSL	2
		OBG	2

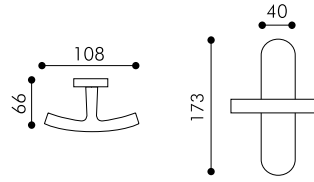
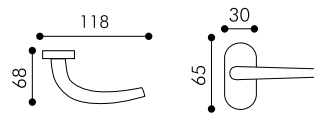
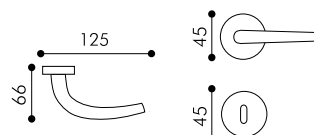
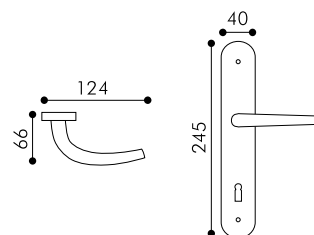



OLV
OTTONE LUCIDO VERNICIATO
POLISHED AND PAINTED BRASS



OCR
CROMO LUCIDO
POLISHED CHROME



CRS
CROMO SATINATO
SATIN CHROME



NKS
NIKEL SATINATO
SATIN NIKEL



OBG
BRONZO GRAFFIATO LUCIDO
SCRATCHED POLISHED BRONZE



CODICE	DESCRIZIONE	FINITURE	IMBALLO
5020	Guarnitura con molla di ritorno su placche Pair spring handles. Plate	OLV	1
		OCR	1
		CRS	1
		NKS	1
		OBG	1
5021	Guarnitura con molla di ritorno su rosette coprivite Pair spring handles. Roses. Screw cover	OLV	1
		OCR	1
		CRS	1
		NKS	1
		OBG	1
5022	Maniglia movimento DK Handle DK movement	OLV	2
		OCR	2
		CRS	2
		NKS	2
		OBG	2
5023	Martellina o cremonese su placca senza fori in vista meccanismo intercambiabile Window Handle: 7mm square spindle or mechanism on plate	OLV	2
		OCR	2
		CRS	2
		NKS	2
		OBG	2
5023/FL	Martellina o cremonese su placca con fori in vista meccanismo intercambiabile Window Handle: 7mm square spindle or mechanism on plate with holes	OLV	2
		OCR	2
		CRS	2
		NKS	2
		OBG	2

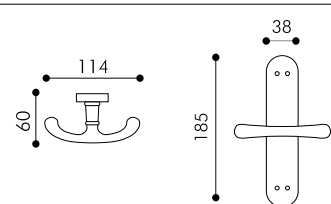
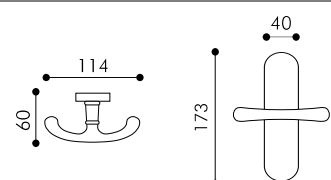
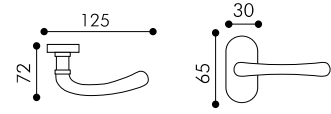
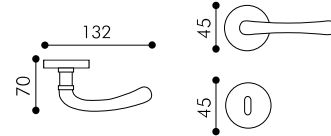
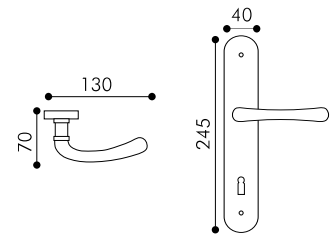



OLV
OTTONE LUCIDO VERNICIATO
POLISHED AND PAINTED BRASS

CRS
CROMO SATINATO
SATIN CHROME

OVI
OTTONE NATURALE OPACO
NATURAL MATT BRASS

OSL
OTTONE SATINATO VERNICIATO
SATINED AND PAINTED BRASS

OBG
BRONZO GRAFFIATO LUCIDO
SCRATCHED POLISHED BRONZE



CODICE	DESCRIZIONE	FINITURE	IMBALLO
5080	Guarnitura con molla di ritorno su placche Pair spring handles. Plate	OLV CRS OSL OVI OBG	1 1 1 1 1
5081	Guarnitura con molla di ritorno su rosette coprivite Pair spring handles. Roses. Screw cover	OLV CRS OSL OVI OBG	1 1 1 1 1
5082	Maniglia movimento DK Handle DK movement	OLV CRS OSL OVI OBG	2 2 2 2 2
5083	Martellina o cremonese su placca senza fori in vista meccanismo intercambiabile Window Handle: 7mm square spindle or mechanism on plate	OLV CRS OSL OVI OBG	2 2 2 2 2
5083/FL	Martellina o cremonese su placca con fori in vista meccanismo intercambiabile Window Handle: 7mm square spindle or mechanism on plate with holes	OLV CRS OSL OVI OBG	2 2 2 2 2

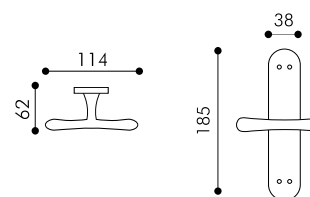
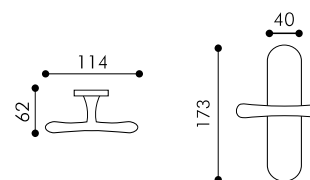
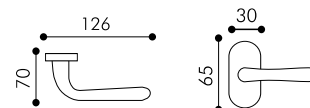
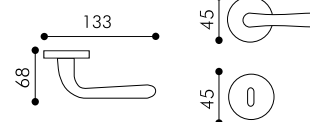
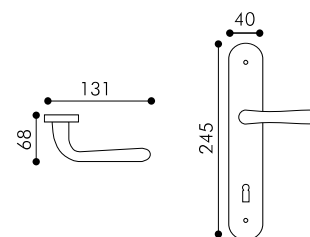



OLV
OTTONE LUCIDO VERNICIATO
POLISHED AND PAINTED BRASS



OCR
CROMO LUCIDO
POLISHED CHROME



CRS
CROMO SATINATO
SATIN CHROME



OBG
BRONZO GRAFFIATO LUCIDO
SCRATCHED POLISHED BRONZE



CODICE	DESCRIZIONE	FINITURE	IMBALLO
5080/Z	Guarnitura con molla di ritorno su placche Pair spring handles. Plate	OLV	1
		OCR	1
		CRS	1
		OBG	1
5081/Z	Guarnitura con molla di ritorno su rosette coprivite Pair spring handles. Roses. Screw cover	OLV	1
		OCR	1
		CRS	1
		OBG	1
5082/Z	Maniglia movimento DK Handle DK movement	OLV	2
		OCR	2
		CRS	2
		OBG	2

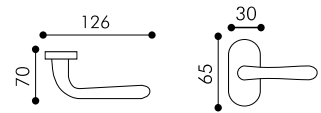
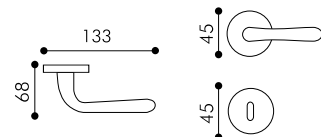
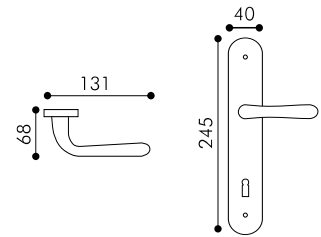



OLV
OTTONE LUCIDO VERNICIATO
POLISHED AND PAINTED BRASS

CRS
CROMO SATINATO
SATIN CHROME

OBG
BRONZO GRAFFIATO LUCIDO
SCRATCHED POLISHED BRONZE

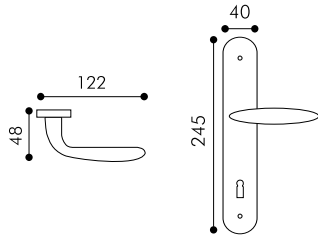
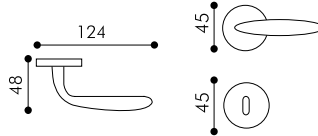
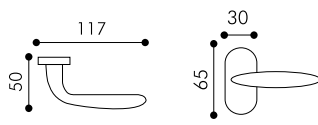
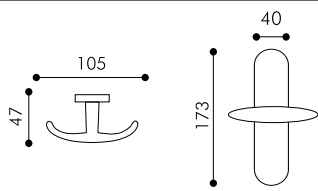
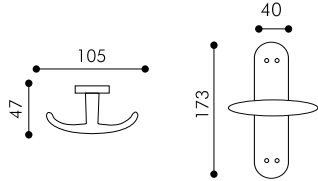

CODICE	DESCRIZIONE	FINITURE	IMBALLO
6020	Guarnitura con molla di ritorno su placche Pair spring handles. Plate	OLV CRS OBG	1 1 1 
6021	Guarnitura con molla di ritorno su rosette coprivite Pair spring handles. Roses. Screw cover	OLV CRS OBG	1 1 1 
6022	Maniglia movimento DK Handle DK movement	OLV CRS OBG	2 2 2 
6023	Martellina o cremonese su placca senza fori in vista meccanismo intercambiabile Window Handle: 7mm square spindle or mechanism on plate	OLV CRS OBG	2 2 2 
6023/F	Martellina o cremonese su placca con fori in vista meccanismo non intercambiabile Window Handle: 7mm square spindle or mechanism on plate with holes	OLV CRS OBG	2 2 2 



OLV
OTTONE LUCIDO VERNICIATO
POLISHED AND PAINTED BRASS



CRS
CROMO SATINATO
SATIN CHROME



OBG
BRONZO GRAFFIATO LUCIDO
SCRATCHED POLISHED BRONZE



CODICE	DESCRIZIONE	FINITURE	IMBALLO
2100	Guarnitura con molla di ritorno su placche Pair spring handles. Plate	OLV CRS OBG	1 1 1
2101	Guarnitura con molla di ritorno su rosette coprivite Pair spring handles. Roses. Screw cover	OLV CRS OBG	1 1 1
2102	Maniglia movimento DK Handle DK movement	OLV CRS OBG	2 2 2



OLV
OTTONE LUCIDO VERNICIATO
POLISHED AND PAINTED BRASS

CRS
CROMO SATINATO
SATIN CHROME

OBG
BRONZO GRAFFIATO LUCIDO
SCRATCHED POLISHED BRONZE

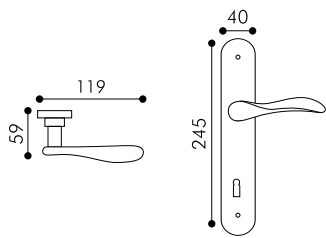
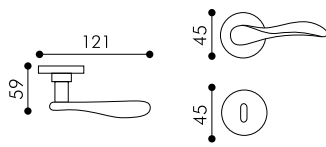
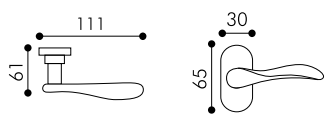
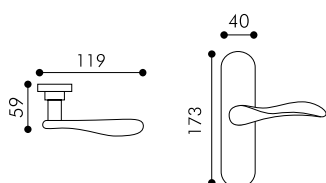

CODICE	DESCRIZIONE	FINITURE	IMBALLO
6010	Guarnitura con molla di ritorno su placche Pair spring handles. Plate	OLV CRS OBG	1 1 1 
6011	Guarnitura con molla di ritorno su rosette coprivite Pair spring handles. Roses. Screw cover	OLV CRS OBG	1 1 1 
6012	Maniglia movimento DK Handle DK movement	OLV CRS OBG	2 2 2 
6014	Martellina o cremonese con impugnatura a maniglia Window Handle: 7mm square spindle or mechanism	OLV CRS OBG	2 2 2 



OLV
OTTONE LUCIDO VERNICIATO
POLISHED AND PAINTED BRASS



CODICE	DESCRIZIONE	FINITURE	IMBALLO	
1751	Guarnitura su rosette con fori in vista Pair handles. Roses. Screw in view	OLV	2	
1753	Martellina o cremonese su placca Window Handle: 7mm square spindle or mechanism on plate	OLV	2	



OBS
BRONZO SATINATO LUCIDO
SCRATCHED POLISHED BRONZE

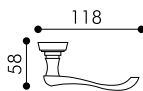
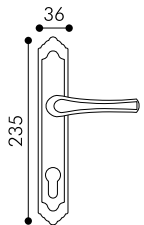
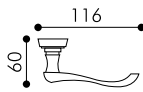
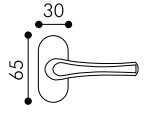
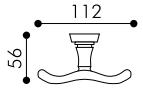
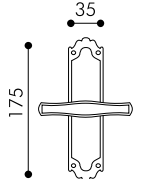

CODICE	DESCRIZIONE	FINITURE	IMBALLO		
1000	Guarnitura senza molla di ritorno su placche Pair handles without spring. Plate	OBS	1		
1002	Maniglia movimento DK Handle DK movement	OBS	2		
1003/F	Martellina o cremonese su placca Window Handle: 7mm square spindle or mechanism on plate with holes	OBS	2		



OLV
OTTONE LUCIDO VERNICIATO
POLISHED AND PAINTED BRASS



OBG
BRONZO GRAFFIATO LUCIDO
SCRATCHED POLISHED BRONZE



CODICE	DESCRIZIONE	FINITURE	IMBALLO
6060	Guarnitura con molla di ritorno su placche Pair spring handles. Plate	OLV OBG	1 1
6061	Guarnitura con molla di ritorno su rosette coprivite Pair spring handles. Roses. Screw cover	OLV OBG	1 1
6062	Maniglia movimento DK Handle DK movement	OLV OBG	2 2
6064	Martellina o cremonese con impugnatura a maniglia Window Handle: 7mm square spindle or mechanism	OLV OBG	2 2



OTTONE - BRASS

BASIC



FL - PC
 FERRO LUCIDO
 PORCELLANA BIANCA
 PAINTED IRON
 WHITE CERAMIC













CODICE	DESCRIZIONE	FINITURE	IMBALLO
5600	Guarnitura senza molla di ritorno su placche Pair handles without spring. Plate	FL - PC	1 
5601	Guarnitura senza molla di ritorno su rosetta Pair handles roses without spring	FL - PC	1 
5603	Martellina quadro 7 mm Window Handle: 7mm	FL - PC	1 



FE - PS
 FERRO RUGGINE
 PORCELLANA SCURA
 RUST IRON
 DARK CERAMIC

CODICE	DESCRIZIONE	FINITURE	IMBALLO
5500	Guarnitura senza molla di ritorno su placche Pair handles without spring. Plate	FE - PS	1 
5501	Guarnitura senza molla di ritorno su rosetta Pair handles roses without spring	FE - PS	1 
5503	Martellina quadro 7 mm Window Handle: 7mm	FE - PS	1 

CODICE	DESCRIZIONE	FINITURE	IMBALLO	
400/CBL	Nottolino a farfalla con rosette tonde ø 45 mm			OTTONE - BRASS
	Wc Rose ø 45 mm	OTTONE LUCIDO VERNICIATO "OLV" BRONZO GRAFFIATO LUCIDO "OBG" CROMO LUCIDO "OCR" CROMO SATINATO "CRS" NIKEL SATINATO "NKS"	6 6 6 6 6	
400/CBP	Nottolino a farfalla con rosette tonde a vitare ø 50 mm			OTTONE - BRASS
	Wc Rose ø 50 mm	OTTONE LUCIDO VERNICIATO "OLV" BRONZO GRAFFIATO LUCIDO "OBG" CROMO LUCIDO "OCR" CROMO SATINATO "CRS" NIKEL SATINATO "NKS"	6 6 6 6 6	
470/CBQ	Nottolino quadrato con rosette quadre 50x50 mm			ZAMA - ZAMAK
	Wc squared rose 50x50 mm	CROMO LUCIDO "OCR" CROMO SATINATO "CRS"	6 6	
400/CBQ	Nottolino rettangolare con rosette quadre 50x50 mm			ZAMA - ZAMAK
	Wc squared rose 50x50 mm	CROMO LUCIDO "OCR" CROMO SATINATO "CRS"	6 6	
	DISPONIBILI ANCHE CON SEGNALATORE DI PRESENZA: ROSSO/BIANCO			
R/WCA	Nottolino Wc in acciaio inox Rosette ø 50 mm con segnalatore di presenza libero/occupato			INOX
	Wc Rose ø 50 mm	INOX/SAT	4	
R/WCB	Nottolino Wc in acciaio inox Rosette ø 50 mm senza segnalatore di presenza libero/occupato			INOX
	Wc Rose ø 50 mm	INOX/SAT	4	

CODICE	DESCRIZIONE	FINITURE	IMBALLO
400/TC	Nottolino oliva con rosette tonde ø 45 mm Wc Rose ø 45 mm		ZAMA/OTTONE - ZAMAK/BRASS
		OTTONE LUCIDO VERNICIATO "OLV" CROMO LUCIDO "OCR" CROMO SATINATO "CRS"	6 6 6
			
400/LO	Nottolino oliva con rosette tonde ø 45 mm con segnalatore di presenza libero/occupato Wc Rose ø 45 mm		ZAMA/OTTONE - ZAMAK/BRASS
		OTTONE LUCIDO VERNICIATO "OLV" CROMO LUCIDO "OCR" CROMO SATINATO "CRS"	6 6 6
			
400/RM5	Nottolino farfalla con rosette tonde ø 45 mm viti in vista Wc Rose ø 45 mm		OTTONE - BRASS
		OTTONE INVECCHIATO PROTETTO "OIP" OTTONE LUCIDO VERNICIATO "OLV" NIKEL NERO FERROANTICO "NA"	6 6 6
			
400	Solo nottolino a farfalla senza rosette Only lever for Wc		ZAMA/OTTONE - ZAMAK/BRASS
		OTTONE LUCIDO VERNICIATO "OLV" CROMO LUCIDO "OCR" CROMO SATINATO "CRS" BRONZO GRAFFIATO LUCIDO "OBG"	10 10 10 10
			
400/E	Solo nottolino oliva senza rosette Only lever for Wc		ZAMA/OTTONE - ZAMAK/BRASS
		OTTONE LUCIDO VERNICIATO "OLV" CROMO LUCIDO "OCR" CROMO SATINATO "CRS"	10 10 10
			

ACCESSORI
ACCESSORIES









Q-CINQUE

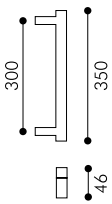

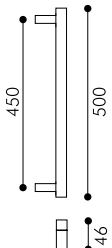
ARIENI

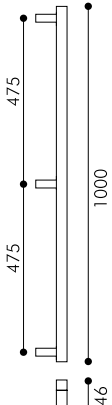
MANIGLIE FATTE IN ITALIA

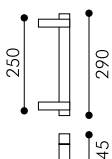
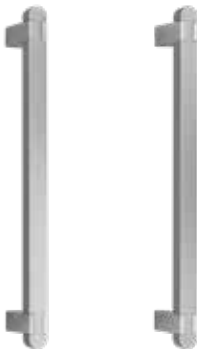
CODICE	DESCRIZIONE	FINITURE	IMBALLO
9039/350	Maniglione Q-Cinque da 350 mm - interasse 300 mm Single pull handle Q-Cinque - 350 mm - wheelbase 300 mm	EFFETTO CROMO SATINATO "ECRS"	1
			
9039/500	Maniglione Q-Cinque da 500 mm - interasse 450 mm Single pull handle Q-Cinque - 500 mm - wheelbase 450 mm	EFFETTO CROMO SATINATO "ECRS"	1
			
9039/1000	Maniglione Q-Cinque da 1000 mm con 3 basi di appoggio Single pull handle Q-Cinque - 1000 mm	EFFETTO CROMO SATINATO "ECRS"	1
			
2809	Maniglione Omega da 290 mm - interasse 250 mm Single pull handle Omega - 290 mm - wheelbase 250 mm	CROMO SATINATO "CRS" BICOLOR CROMO LUC/SAT "OCR/CRS"	1 1
			

MANIGLIONI

PULL HANDLES









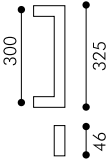

QUADRA

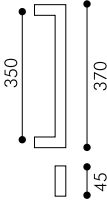

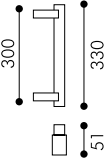
ARIENI

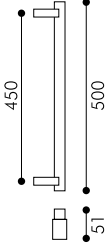

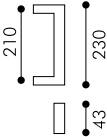
M A N I G L I E F A T T E I N I T A L I A

CODICE	DESCRIZIONE	FINITURE	IMBALLO	
9350	Maniglione Quadra da 325 mm - interasse 300 mm Single pull handle Quadra - 325 mm - wheelbase 300 mm			LEGA 6060
		EFFETTO CROMO SATINATO "ECSR" CROMO LUCIDO "OCR"	1 1	
9370	Maniglione Quadra da 370 mm - interasse 350 mm Single pull handle Quadra - 370 mm - wheelbase 350 mm			OTTONE / BRASS
		CROMO SATINATO "CRS" CROMO LUCIDO "OCR"	1 1	
9059	Maniglione Sirio da 330 mm - interasse 300 mm Single pull handle Sirio - 330 mm - wheelbase 300 mm			OTTONE / BRASS
		CROMO SATINATO "CRS" BICOLOR CROMO LUC/SAT "OCR/CRS"	1 1	
9059/500	Maniglione Sirio da 500 mm - interasse 450 mm Single pull handle Sirio - 500 mm - wheelbase 450 mm			OTTONE / BRASS
		CROMO SATINATO "CRS" BICOLOR CROMO LUC/SAT "OCR/CRS"	1 1	
9067	Maniglione Quadra Sport da 230 mm - interasse 210 mm Single pull handle Quadra Sport - 230 mm - wheelbase 210 mm			ZAMA / ZAMAK
		CROMO SATINATO "CRS" CROMO LUCIDO "OCR" NERO "NE" BIANCO "BNC"	1 1 1 1	

MANIGLIONI

PULL HANDLES

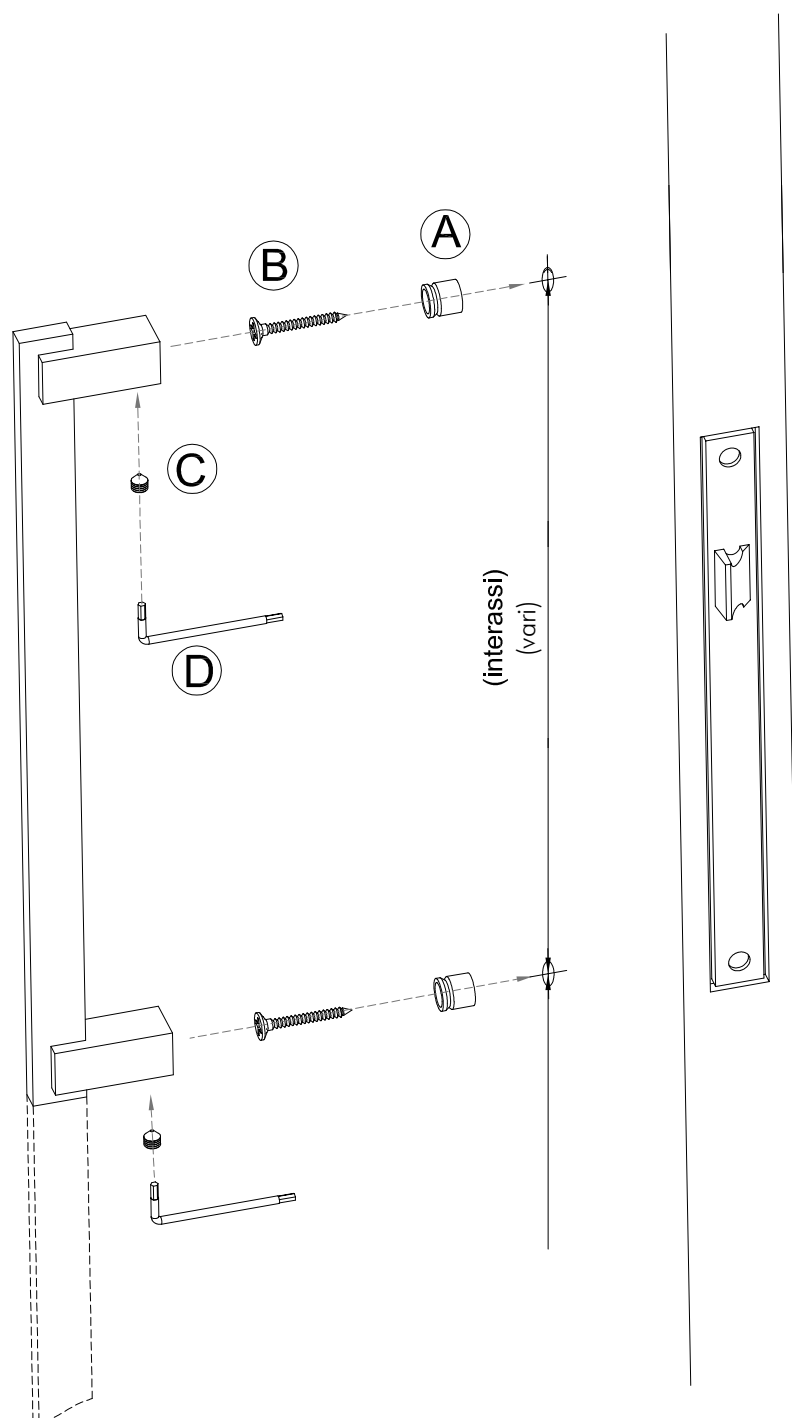



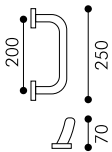

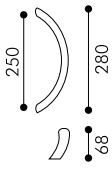

SCHEMA DI MONTAGGIO MANIGLIONI SENZA ROSETTE

- 1) fissare LE BUSSOLE (A) mediante le VITI AUTOFILETTANTI (B) all'interasse del maniglione da montare.
- 2) inserire il MANIGLIONE sulle bussoline (A).
- 3) fissare il MANIGLIONE serrando i GRANI (C), utilizzandola CHIAVE (D).

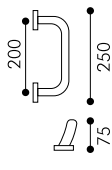
CODICE	DESCRIZIONE	FINITURE	IMBALLO
940/E	<p>Maniglione Stile Rosetta ø 45 mm</p> <p>Single pull handle Stile Rose ø 45</p> 	<p>OTTONE LUCIDO PVD "PVD"</p> <p>OTTONE LUCIDO VERNICIATO "OLV"</p> <p>CROMO LUCIDO "OCR"</p> <p>CROMO SATINATO "CRS"</p> <p>BRONZO GRAFFIATO LUCIDO "OBG"</p>	<p>OTTONE / BRASS</p> <p>1</p> <p>1</p> <p>1</p> <p>1</p> <p>1</p> 
950	<p>Maniglione Urano base appoggio 35x35 mm</p> <p>Single pull handle Urano rose 35x35 mm</p> 	<p>OTTONE LUCIDO VERNICIATO "OLV"</p> <p>OTTONE LUCIDO NON VERNICIATO "OLN"</p> <p>BRONZO GRAFFIATO LUCIDO "OBG"</p>	<p>OTTONE / BRASS</p> <p>1</p> <p>1</p> <p>1</p> 
992	<p>Maniglione Margherita Rosetta ø 55 mm</p> <p>Single pull handle Margherita Rose ø 55 mm</p> 	<p>OTTONE LUCIDO PVD "PVD"</p> <p>OTTONE LUCIDO VERNICIATO "OLV"</p> <p>CROMO SATINATO "CRS"</p> <p>BRONZO GRAFFIATO LUCIDO "OBG"</p>	<p>OTTONE / BRASS</p> <p>1</p> <p>1</p> <p>1</p> <p>1</p> 
770	<p>Maniglione Aba Rosetta a vitare ø 50</p> <p>Single pull handle Aba Rose ø 50</p> 	<p>OTTONE LUCIDO PVD "PVD"</p> <p>OTTONE LUCIDO VERNICIATO "OLV"</p> <p>CROMO LUCIDO "OCR"</p> <p>CROMO SATINATO "CRS"</p> <p>BRONZO GRAFFIATO LUCIDO "OBG"</p>	<p>OTTONE / BRASS</p> <p>1</p> <p>1</p> <p>1</p> <p>1</p> <p>1</p> 

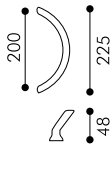
MANIGLIONI

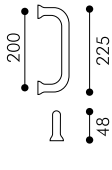



PULL HANDLES

CODICE	DESCRIZIONE	FINITURE	IMBALLO
771	<p>Maniglione Lusso Pesante senza rosetta</p> <p>Single pull handle Big without rose</p> 	<p>OTTONE LUCIDO VERNICIATO "OLV" 1</p> <p>CROMO LUCIDO "OCR" 1</p> <p>CROMO SATINATO "CRS" 1</p> <p>BRONZO GRAFFIATO LUCIDO "OBG" 1</p>	<p>OTTONE / BRASS</p> 
716	<p>Maniglione Alicante Rosetta ø 55 mm</p> <p>Single pull handle Alicante Rose ø 55</p> 	<p>OTTONE LUCIDO PVD "PVD" 1</p> <p>OTTONE LUCIDO VERNICIATO "OLV" 1</p> <p>CROMO SATINATO "CRS" 1</p> <p>BRONZO GRAFFIATO LUCIDO "OBG" 1</p>	<p>OTTONE / BRASS</p> 
980	<p>Maniglione Sliding zancato senza rosetta</p> <p>Single pull handle Sliding without rose</p> 	<p>OTTONE LUCIDO PVD "PVD" 1</p> <p>OTTONE LUCIDO VERNICIATO "OLV" 1</p> <p>CROMO SATINATO "CRS" 1</p> <p>BRONZO GRAFFIATO LUCIDO "OBG" 1</p>	<p>OTTONE / BRASS</p> 
970	<p>Maniglione Sliding diritto senza rosetta</p> <p>Single pull handle Sliding without rose</p> 	<p>OTTONE LUCIDO VERNICIATO "OLV" 1</p> <p>CROMO SATINATO "CRS" 1</p> <p>BRONZO GRAFFIATO LUCIDO "OBG" 1</p>	<p>OTTONE / BRASS</p> 

MANIGLIONI

PULL HANDLES





CODICE	DESCRIZIONE	FINITURE	IMBALLO	
101/C	Pomolo Victorian. Rosetta ad avvitare ø 50 mm coprivite Pull knob Victorian Rose ø 50 mm	OTTONE LUCIDO VERNICIATO "OLV" CROMO LUCIDO "OCR" CROMO SATINATO "CRS" BRONZO GRAFFIATO LUCIDO "OBG" NIKEL SATINATO "NKS"	2 2 2 2 2	OTTONE / BRASS 
101	Pomolo Victorian. Rosetta ovale con fori in vista Pull knob Victorian Oval rose with holes	OTTONE LUCIDO VERNICIATO "OLV" CROMO LUCIDO "OCR" CROMO SATINATO "CRS" BRONZO GRAFFIATO LUCIDO "OBG" NIKEL SATINATO "NKS"	2 2 2 2 2	OTTONE / BRASS 
127/N	Pomolo Nettuno ø 70 mm con rosone e accessori fissaggio esterno e passante Pull knob Eco ø 70 mm Rose Fixing system included	OTTONE LUCIDO PVD "PVD" OTTONE LUCIDO VERNICIATO "OLV" CROMO SATINATO "CRS" BRONZO GRAFFIATO LUCIDO "OBG"	2 2 2 2	OTTONE / BRASS 
126	Pomolo Impero ø 70 mm con rosone e accessori fissaggio esterno e passante Pull knob Impero ø 70 mm Rose Fixing system included	OTTONE LUCIDO PVD "PVD" OTTONE LUCIDO VERNICIATO "OLV" CROMO SATINATO "CRS" BRONZO GRAFFIATO LUCIDO "OBG"	2 2 2 2	OTTONE / BRASS 
127	Pomolo Margherita ø 70 mm con rosone e accessori fissaggio esterno e passante Pull knob Margherita ø 70 mm Rose Fixing system included	OTTONE LUCIDO PVD "PVD" OTTONE LUCIDO VERNICIATO "OLV" CROMO SATINATO "CRS" BRONZO GRAFFIATO LUCIDO "OBG"	2 2 2 2	OTTONE / BRASS 

CODICE	DESCRIZIONE	FINITURE	IMBALLO	
114	Pomolo Bongo ø 70 mm montaggio esterno con rosetta ø 50 mm accessori fissaggio			OTTONE / BRASS
	Pull knob Bongo ø 70 mm Rose ø 50 mm External fixing system included	OTTONE LUCIDO PVD "PVD" OTTONE LUCIDO VERNICIATO "OLV" CROMO SATINATO "CRS" BRONZO GRAFFIATO LUCIDO "OBG"	2 2 2 2	
104	Pomolo a sfera ø 50 mm montaggio esterno con rosetta ø 50 mm accessori fissaggio			OTTONE / BRASS
	Pull knob ø 50 mm Rose ø 50 mm External fixing system included	OTTONE LUCIDO VERNICIATO "OLV" CROMO SATINATO "CRS" BRONZO GRAFFIATO LUCIDO "OBG"	2 2 2	
123	Pomolo Cipolla monoblocco ø 67 mm con accessori per montaggio esterno			OTTONE / BRASS
	Pull knob Cipolla ø 67 mm Fixing system	OTTONE LUCIDO VERNICIATO "OLV" CROMO SATINATO "CRS" BRONZO GRAFFIATO LUCIDO "OBG"	2 2 2	
132	Pomolo Centroporta monoblocco ø 67 mm con accessori per montaggio esterno			OTTONE / BRASS
	Pull knob Centroporta ø 67 mm Fixing system	OTTONE LUCIDO VERNICIATO "OLV" CROMO SATINATO "CRS" BRONZO GRAFFIATO LUCIDO "OBG"	2 2 2	
128/E	Pomolo Svezia ø 65 mm montaggio esterno con rosetta ø 50 mm accessori fissaggio			OTTONE / BRASS
	Pull knob Svezia ø 65 mm Rose ø 50 mm External fixing system included	OTTONE LUCIDO VERNICIATO "OLV" CROMO SATINATO "CRS" BRONZO GRAFFIATO LUCIDO "OBG"	2 2 2	

POMOLI
SINGOLI FISSI





KNOBS

CODICE	DESCRIZIONE	FINITURE	IMBALLO	
128	<p>Pomolo Svezia ø 65 mm con rosone e accessori fissaggio esterno e passante</p> <p>Pull knob Svezia ø 65 mm Fixing system included</p>	<p>OTTONE LUCIDO PVD "PVD" OTTONE LUCIDO VERNICIATO "OLV" CROMO SATINATO "CRS" BRONZO GRAFFIATO LUCIDO "OBG"</p>	<p>2 2 2 2</p>	<p>OTTONE / BRASS</p> 
906	<p>Pomolo Quadro 60x60 mm rosetta quadra 50x50 mm con accessori di montaggio.</p> <p>Squared knob 60x60 mm squared rose 50x50 mm fixing system included.</p>	<p>CROMO LUCIDO "OCR" CROMO SATINATO "CRS" NERO "NE" BIANCO "BNC"</p>	<p>2 2 2 2</p>	<p>OTTONE / BRASS</p> 
904	<p>Pomolo Quadro 62x62 mm rosetta quadra 50x50 mm con accessori di montaggio.</p> <p>Squared knob 62x62 mm squared rose 50x50 mm fixing system included.</p>	<p>OTTONE LUCIDO VERNICIATO "OLV" CROMO LUCIDO "OCR" CROMO SATINATO "CRS"</p>	<p>2 2 2</p>	<p>OTTONE / BRASS</p> 
907	<p>Pomolo Quadro 55x55 mm rosetta quadra 50x50 mm con accessori di montaggio.</p> <p>Squared knob 55x55 mm squared rose 50x50 mm fixing system included.</p>	<p>CROMO LUCIDO "OCR" CROMO SATINATO "CRS"</p>	<p>2 2</p>	<p>ZAMA / ZAMAK</p> 

CODICE	DESCRIZIONE	FINITURE	IMBALLO	
151	Coppia pomolo Idra Rosetta ø 45 mm			OTTONE / BRASS
	Pair knob Idra Rose ø 45 mm	OTTONE LUCIDO PVD "PVD" OTTONE LUCIDO VERNICIATO "OLV" OTTONE SATINATO VERNICIATO "OSL" CROMO LUCIDO "OCR" CROMO SATINATO "CRS" BRONZO GRAFFIATO LUCIDO "OBG" NIKEL SATINATO "NKS"	1 1 1 1 1 1 1	
151/F	Coppia pomolo Idra Rosetta ovale fori in vista			OTTONE / BRASS
	Pair knob Idra Oval rose with holes	OTTONE LUCIDO VERNICIATO "OLV" CROMO SATINATO "CRS" BRONZO GRAFFIATO LUCIDO "OBG" NIKEL SATINATO "NKS"	1 1 1 1	
151/C	Coppia pomolo Idra Rosetta ø 50 mm			OTTONE / BRASS
	Pair knob Idra Rose ø 50 mm	OTTONE LUCIDO VERNICIATO "OLV" OTTONE SATINATO VERNICIATO "OSL" CROMO LUCIDO "OCR" CROMO SATINATO "CRS" BRONZO GRAFFIATO LUCIDO "OBG" NIKEL SATINATO "NKS"	1 1 1 1 1 1	
102	Coppia pomolo Victoria Rosetta ovale fori in vista			OTTONE / BRASS
	Pair knob Victoria Oval rose with holes	OTTONE LUCIDO VERNICIATO "OLV" CROMO SATINATO "CRS" BRONZO GRAFFIATO LUCIDO "OBG" NIKEL SATINATO "NKS"	1 1 1 1	
102/C	Coppia pomolo Victoria Rosetta ø 50 mm			OTTONE / BRASS
	Pair knob Victoria Rose ø 50 mm	OTTONE LUCIDO VERNICIATO "OLV" CROMO LUCIDO "OCR" CROMO SATINATO "CRS" BRONZO GRAFFIATO LUCIDO "OBG" NIKEL SATINATO "NKS"	1 1 1 1 1	

**COPPIA
POMOLI**

KNOBS

CODICE	DESCRIZIONE	FINITURE	IMBALLO	
106	Coppia pomolo Giove Rosetta ø 45 mm			OTTONE / BRASS
	Pair knob Giove Rose ø 45 mm	OTTONE LUCIDO VERNICIATO "OLV" CROMO SATINATO "CRS" BRONZO GRAFFIATO LUCIDO "OBG"	1 1 1	
141	Coppia pomolo Pigna Rosetta ø 50 mm			OTTONE / BRASS
	Pair knob Pigna Rose ø 50 mm	OTTONE LUCIDO VERNICIATO "OLV" CROMO SATINATO "CRS" BRONZO GRAFFIATO LUCIDO "OBG"	1 1 1	
108	Coppia pomolo Cigno Rosetta ø 50 mm			OTTONE / BRASS
	Pair knob Cigno Rose ø 50 mm	Porcellana chiara White ceramic OTTONE LUCIDO VERNICIATO "OLV" BRONZO ANTICO OPACO "ANT"	1 1	
		Porcellana scura Dark ceramic OTTONE LUCIDO VERNICIATO "OLV" BRONZO ANTICO OPACO "ANT"	1 1	
908	Coppia pomolo Quadro 60x 60 mm Rosetta 50x50 mm			OTTONE / BRASS
	Pair squared knobs 60x60 mm Rose 50x50 mm	CROMO LUCIDO "OCR" CROMO SATINATO "CRS" NERO "NE" BIANCO "BNC"	1 1 1 1	
909	Coppia pomolo Quadro 55x55 mm decentrato Rosetta 50x50 mm			ZAMA / ZAMAK
	Pair squared knobs 55x55 mm Rose 50x50 mm	CROMO LUCIDO "OCR" CROMO SATINATO "CRS"	1 1	

COPPIA
POMOLI

KNOBS

CODICE	DESCRIZIONE	FINITURE	IMBALLO
8069/A	Impugnatura maniglia Dolly con pomolo Svezia fisso e rosetta \varnothing 50 mm sistema di montaggio A Handle Dolly knob Svezia on rose \varnothing 50 mm fixed mounting system A	OTTONE LUCIDO VERNICIATO "OLV" CROMO SATINATO "CRS" BRONZO GRAFFIATO LUCIDO "OBG"	OTTONE / BRASS 1 1 1

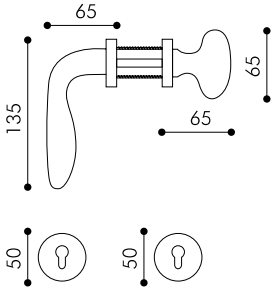

7069/A	Impugnatura maniglia S-Quadra con pomolo Quadro fisso e rosetta 50x50 mm sistema di montaggio A Handle S-Quadra knob Quadro on rose 50x50 mm fixed mounting system A	CROMO LUCIDO "OCR" CROMO SATINATO "CRS"	OTTONE - ZAMA / BRASS - ZAMAK 1 1
---------------	---	--	---

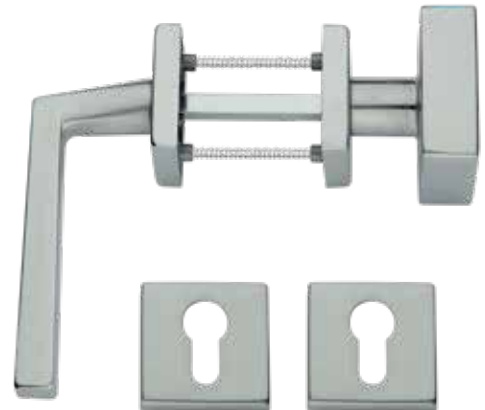
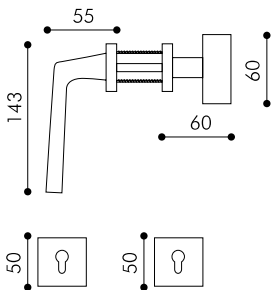

A

Schema di montaggio A
con viti passanti e nipples

Mounting system A

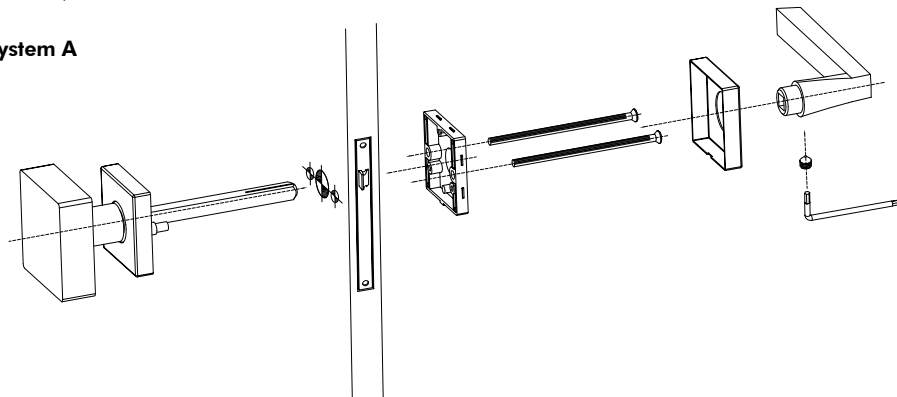

**KIT
HOTEL**

IMPORTANTE SPECIFICARE "LA MANO"
DELL'IMPUGNATURA MANIGLIA

CODICE	DESCRIZIONE	FINITURE	IMBALLO
8069/B	Impugnatura maniglia Dolly con pomolo Svezia fisso e rosetta \varnothing 50 mm sistema di montaggio B	OTTONE LUCIDO VERNICIATO "OLV" CROMO SATINATO "CRS" BRONZO GRAFFIATO LUCIDO "OBG"	1 1 1
	Handle Dolly knob Svezia on rose \varnothing 50 mm fixed mounting system B		

OTTONE / BRASS

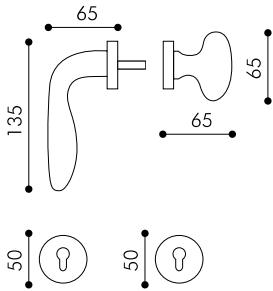

7069/B	Impugnatura maniglia S-Quadra con pomolo Quadro fisso e rosetta 50x50 mm sistema di montaggio B	CROMO LUCIDO "OCR" CROMO SATINATO "CRS"	1 1
	Handle S-Quadra knob Quadro on rose 50x50 mm fixed mounting system B		

OTTONE - ZAMA / BRASS - ZAMAK

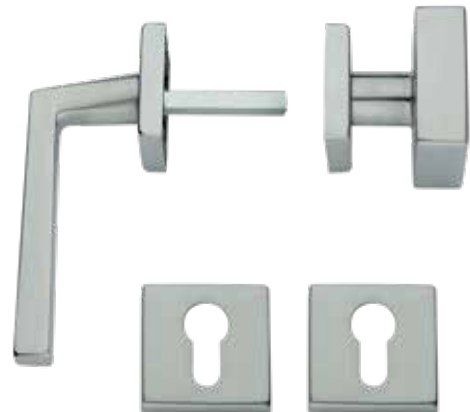
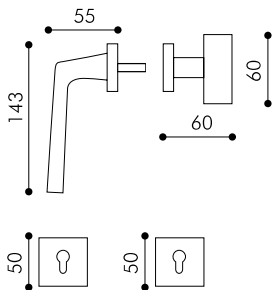

B

Schema di montaggio B
con con quadro ad espansione e dummy

Mounting system B

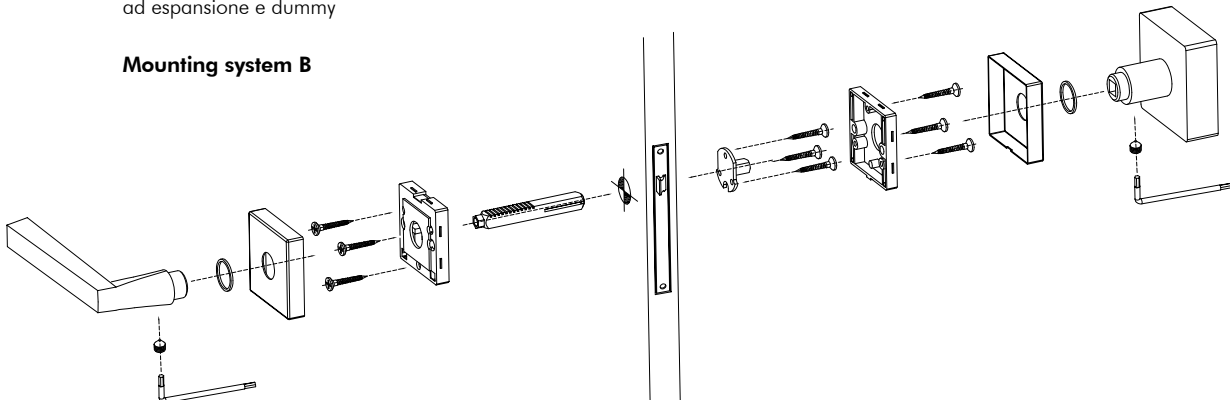

IMPORTANTE SPECIFICARE "LA MANO" DELL'IMPUGNATURA MANIGLIA

KIT HOTEL

CODICE	DESCRIZIONE	FINITURE	IMBALLO
94/SP/Q	<p>Kit nicchie quadre 55x55 mm nottolino di chiusura Ditale di trascinamento con serratura</p> <p>Sliding kit. Roses 55x55 mm Wc Finger pull Lock</p>	<p>OTTONE LUCIDO VERNICIATO "OLV" CROMO LUCIDO "OCR" CROMO SATINATO "CRS" BRONZO GRAFFIATO LUCIDO "OBG"</p>	<p>1 1 1 1</p>
94/Q	<p>Kit nicchie quadre 55x55 mm nottolino di chiusura Ditale di trascinamento con serratura</p> <p>Sliding kit. Roses 55x55 mm Wc Finger pull Lock</p>	<p>OTTONE LUCIDO VERNICIATO "OLV" CROMO LUCIDO "OCR" CROMO SATINATO "CRS" BRONZO GRAFFIATO LUCIDO "OBG" BIANCO "BNC" NERO "NE"</p>	<p>1 1 1 1 1 1</p>
95/Q	<p>Kit nicchie quadre 55x55 mm chiave snodata Ditale di trascinamento con serratura</p> <p>Sliding kit. Roses 55x55 mm Key Finger pull Lock</p>	<p>OTTONE LUCIDO VERNICIATO "OLV" CROMO LUCIDO "OCR" CROMO SATINATO "CRS" BRONZO GRAFFIATO LUCIDO "OBG"</p>	<p>1 1 1 1</p>
95/SF/Q	<p>Kit nicchie quadre 55x55 mm senza foro Ditale di trascinamento senza serratura</p> <p>Sliding kit. Roses 55x55 mm Finger pull</p>	<p>OTTONE LUCIDO VERNICIATO "OLV" CROMO LUCIDO "OCR" CROMO SATINATO "CRS" BRONZO GRAFFIATO LUCIDO "OBG" BIANCO "BNC" NERO "NE"</p>	<p>1 1 1 1 1 1</p>

**KIT PER
SCORREVOLI**
SLIDING SET

CODICE	DESCRIZIONE	FINITURE	IMBALLO
14	Kit nicchie tonde ø 70 mm nottolino di chiusura Ditale di trascinamento con serratura Sliding kit. Roses ø 70 mm Wc Finger pull Lock	OTTONE LUCIDO VERNICIATO "OLV" CROMO LUCIDO "OCR" CROMO SATINATO "CRS"	1 1 1   

15	Kit nicchie tonde ø 70 mm chiave snodata Ditale di trascinamento con serratura Sliding kit. Roses ø 70 mm Key Finger pull Lock	OTTONE LUCIDO VERNICIATO "OLV" CROMO LUCIDO "OCR" CROMO SATINATO "CRS"	1 1 1   
----	---	--	--

15/SF	Kit nicchie tonde ø 70 mm senza foro Ditale di trascinamento senza serratura Sliding kit. Roses ø 70 mm Finger pull	OTTONE LUCIDO VERNICIATO "OLV" CROMO LUCIDO "OCR" CROMO SATINATO "CRS"	1 1 1  
-------	---	--	--

**KIT CON CORNICI
MAGGIORATE**

REAL KIT

CODICE	DESCRIZIONE	FINITURE	IMBALLO
14/Q	<p>Kit nicchie quadre 70x70 mm nottolino di chiusura Ditale di trascinamento con serratura</p> <p>Sliding kit. Roses 70x70 mm Wc Finger pull Lock</p>	<p>CROMO LUCIDO "OCR" CROMO SATINATO "CRS"</p>	<p>1 1</p>



15/Q	<p>Kit nicchie quadre 70x70 mm chiave snodata Ditale di trascinamento con serratura</p> <p>Sliding kit. Roses 70x70 mm Key Finger pull Lock</p>	<p>CROMO LUCIDO "OCR" CROMO SATINATO "CRS"</p>	<p>1 1</p>
------	---	--	----------------



15/SF/Q	<p>Kit nicchie quadre 70x70 mm senza foro Ditale di trascinamento senza serratura</p> <p>Sliding kit. Roses 70x70 mm Finger pull</p>	<p>CROMO LUCIDO "OCR" CROMO SATINATO "CRS"</p>	<p>1 1</p>
---------	---	--	----------------

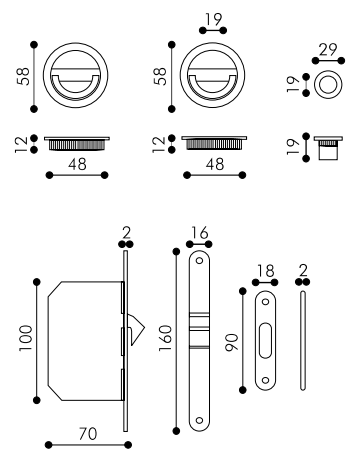
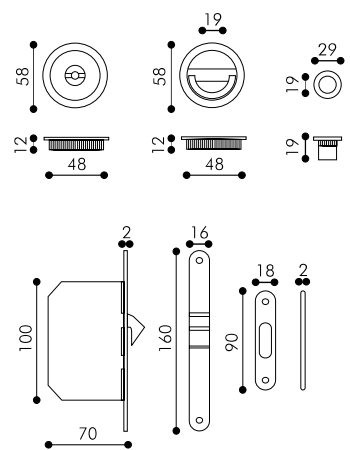
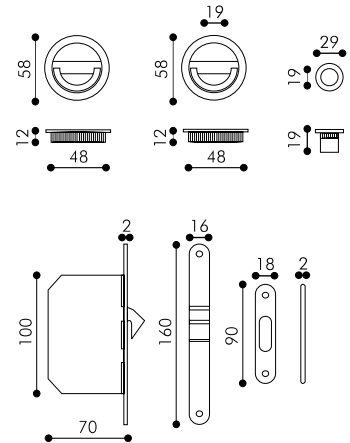

**KIT CON CORNICI
MAGGIORATE**

CODICE	DESCRIZIONE	FINITURE	IMBALLO
94/A	<p>Kit nicchie tonde ø 58 mm con doppio anello pendente azionante da entrambi i lati con ditale di trascinamento con serratura</p> <p><i>utilizzabile anche per porte a pacchetto</i></p> <p>Sliding kit. Roses ø 58 mm Finger pull Lock</p>	<p>OTTONE LUCIDO VERNICIATO "OLV" 1 CROMO LUCIDO "OCR" 1 CROMO SATINATO "CRS" 1 BRONZO GRAFFIATO LUCIDO "OBG" 1</p>	
94/AT	<p>Kit nicchie tonde ø 58 mm con anello pendente e nottolino per apertura di sicurezza con ditale di trascinamento con serratura</p> <p>Sliding kit. Roses ø 58 mm Finger pull Lock</p>	<p>OTTONE LUCIDO VERNICIATO "OLV" 1 CROMO LUCIDO "OCR" 1 CROMO SATINATO "CRS" 1 BRONZO GRAFFIATO LUCIDO "OBG" 1</p>	
94/AF	<p>Kit nicchie tonde ø 58 mm con doppio anello pendente azionante solo lato interno con ditale di trascinamento con serratura</p> <p>Sliding kit. Roses ø 58 mm Finger pull Lock</p>	<p>OTTONE LUCIDO VERNICIATO "OLV" 1 CROMO LUCIDO "OCR" 1 CROMO SATINATO "CRS" 1 BRONZO GRAFFIATO LUCIDO "OBG" 1</p>	

**KIT PER SCORREVOLI
 CON ANELLO PENDENTE**

SLIDING SET

CODICE	DESCRIZIONE	FINITURE	IMBALLO
94/A/Q	<p>Kit nicchie quadre 55x55 mm con doppio anello pendente azionante da entrambi i lati con ditale di trascinamento con serratura</p> <p><i>utilizzabile anche per porte a pacchetto</i></p> <p>Sliding kit. Roses 55x55 mm Finger pull Lock</p>	<p>CROMO LUCIDO "OCR" CROMO SATINATO "CRS"</p>	<p>1 1</p>



94/AT/Q	<p>Kit nicchie quadre 55x55 mm con anello pendente e nottolino per apertura di sicurezza con ditale di trascinamento con serratura</p> <p>Sliding kit. Roses 55x55 mm Finger pull Lock</p>	<p>CROMO LUCIDO "OCR" CROMO SATINATO "CRS"</p>	<p>1 1</p>
----------------	--	--	----------------

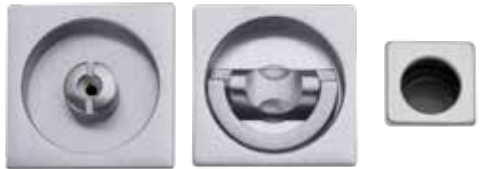

94/AF/Q	<p>Kit nicchie quadre 55x55 mm con doppio anello pendente azionante solo lato interno con ditale di trascinamento con serratura</p> <p>Sliding kit. Roses 55x55 mm Finger pull Lock</p>	<p>CROMO LUCIDO "OCR" CROMO SATINATO "CRS"</p>	<p>1 1</p>
----------------	---	--	----------------

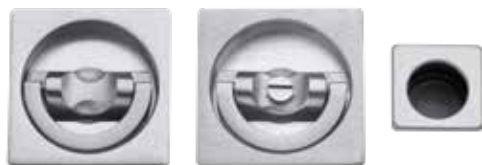

**KIT PER SCORREVOLI
CON ANELLO PENDENTE**

SLIDING SET

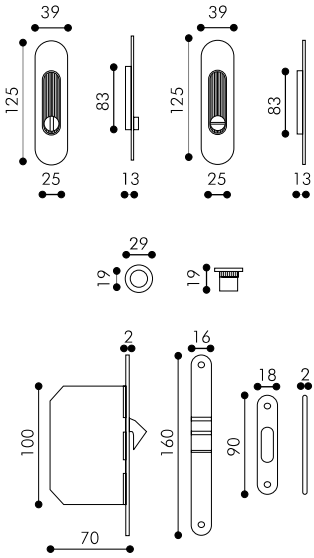
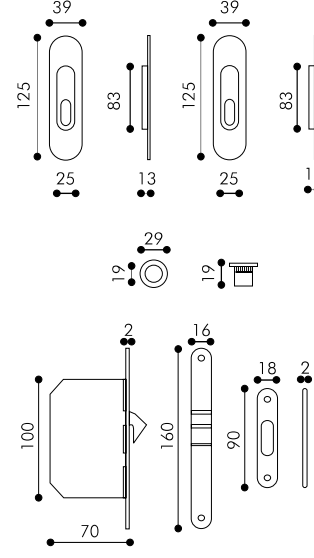
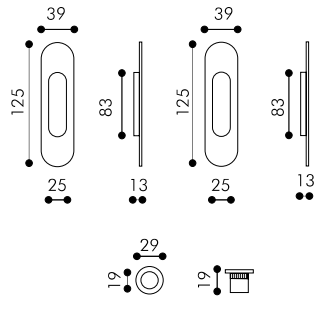
CODICE	DESCRIZIONE	FINITURE	IMBALLO	
98	Kit nicchie ovali nottolino di chiusura. Ditale di trascinamento con serratura	OTTONE LUCIDO VERNICIATO "OLV" CROMO SATINATO "CRS"	1 1	
99	Kit nicchie ovali chiave snodata. Ditale di trascinamento con serratura	OTTONE LUCIDO VERNICIATO "OLV" CROMO SATINATO "CRS"	1 1	
98/SF	Kit nicchie ovali senza foro Ditale di trascinamento senza serratura	OTTONE LUCIDO VERNICIATO "OLV" CROMO SATINATO "CRS"	1 1	

**KIT PER
SCORREVOLI**

SLIDING SET

CODICE	DESCRIZIONE	FINITURE	IMBALLO	
98/R	Kit nicchie rettangolari nottolino di chiusura. Ditale di trascinamento con serratura	OTTONE LUCIDO VERNICIATO "OLV" CROMO SATINATO "CRS"	1 1	
	Sliding kit. Rectangular. Wc Finger pull Lock			

99/R	Kit nicchie rettangolari chiave snodata. Ditale di trascinamento con serratura	OTTONE LUCIDO VERNICIATO "OLV" CROMO SATINATO "CRS"	1 1	
	Sliding kit. Rectangular. Key Finger pull Lock			

98/SF/R	Kit nicchie rettangolari senza foro Ditale di trascinamento senza serratura	OTTONE LUCIDO VERNICIATO "OLV" CROMO SATINATO "CRS"	1 1	
	Sliding kit. Rectangular. Finger pull			

**KIT PER
SCORREVOLI**
SLIDING SET

CODICE	DESCRIZIONE	FINITURE	IMBALLO
--------	-------------	----------	---------

82
 Kit nicchie quadre
 55x55 mm
 nottolino di chiusura
 Ditale di trascinamento
con serratura
 Sliding kit. Roses
 55x55 mm
 Wc
 Finger pull
Lock

CROMO LUCIDO "OCR"
 CROMO SATINATO "CRS"

1
 1

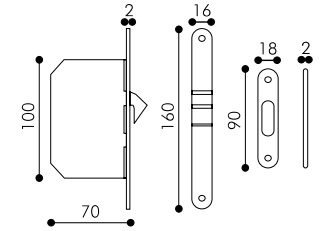
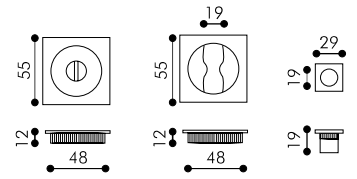

INSERTI:
 CRISTALLO O BLU COBALTO

ABBINABILE ALLA MANIGLIA: BOEMIA



83
 Kit nicchie quadre
 55x55 mm
 nottolino di chiusura
 Ditale di trascinamento
con serratura
 Sliding kit. Roses
 55x55 mm
 Wc
 Finger pull
Lock

CROMO LUCIDO "OCR"
 CROMO SATINATO "CRS"

1
 1

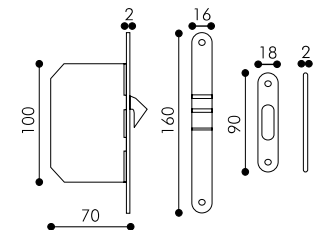
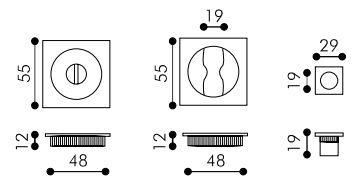





INSERTI:
 CRISTALLO O ACQUAMARINA

ABBINABILE ALLA MANIGLIA: PREZIOSA



**KIT PER
 SCORREVOLI**

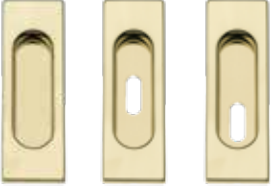

SLIDING SET

CODICE	DESCRIZIONE	FINITURE	IMBALLO	
201/ATP	Singola placca ad incasso ovale 39x125 mm fori vite coperti con o senza foro chiave	OTTONE LUCIDO VERNICIATO "OLV" CROMO LUCIDO "OCR" CROMO SATINATO "CRS" BRONZO GRAFFIATO LUCIDO "OBG"	6 6 6 6	
	Sliding Kit 39x125 mm	<p>disponibile nella versione:</p> <ul style="list-style-type: none"> - senza foro chiave - foro chiave centrale - foro chiave basso 		
201/ATP/R	Singola placca ad incasso rettangolare 39x125 mm fori vite coperti con o senza foro chiave	OTTONE LUCIDO VERNICIATO "OLV" CROMO LUCIDO "OCR" CROMO SATINATO "CRS" BRONZO GRAFFIATO LUCIDO "OBG"	6 6 6 6	
	Sliding Kit 39x125 mm	<p>disponibile nella versione:</p> <ul style="list-style-type: none"> - senza foro chiave - foro chiave centrale - foro chiave basso 		
207	Singola placca ad incasso da 245x40 mm specificare con o senza foro chiave scasso 90x30 mm.			
	Sliding plate	OTTONE LUCIDO VERNICIATO "OLV" CROMO SATINATO "CRS" BRONZO GRAFFIATO LUCIDO "OBG"	12 12 12	

ACCESSORI PER
SCORREVOLI

CODICE	DESCRIZIONE	FINITURE	IMBALLO		
90	Anello di trascinamento ad incasso base 55x40 mm Sliding ring.	OTTONE LUCIDO VERNICIATO "OLV"	12		
		CROMO LUCIDO "OCR"	12		
		CROMO SATINATO "CRS"	12		
		BRONZO GRAFFIATO LUCIDO "OBG"	12		
202/SP	Singole nicchiette di trascinamento per scorrevoli Sliding ring.	foro mm 26 esterno mm 30			
		OTTONE LUCIDO VERNICIATO "OLV"	12		
		CROMO LUCIDO "OCR"	12		
		CROMO SATINATO "CRS"	12		
		BRONZO GRAFFIATO LUCIDO "OBG"	12		
		foro mm 35 esterno mm 40		12	
		OTTONE LUCIDO VERNICIATO "OLV"	12		
		CROMO LUCIDO "OCR"	12		
		CROMO SATINATO "CRS"	12		
		BRONZO GRAFFIATO LUCIDO "OBG"	12		
		foro mm 40 esterno mm 45		12	
		OTTONE LUCIDO VERNICIATO "OLV"	12		
		CROMO LUCIDO "OCR"	12		
		CROMO SATINATO "CRS"	12		
		BRONZO GRAFFIATO LUCIDO "OBG"	12		
202	Singola placca ad incasso tonda ø 58 mm con o senza foro chiave Round insert handle ø 58 mm with/without key hole	OTTONE LUCIDO VERNICIATO "OLV"	12		
		CROMO LUCIDO "OCR"	12		
		CROMO SATINATO "CRS"	12		
		BRONZO GRAFFIATO LUCIDO "OBG"	12		
202/Q	Singola placca ad incasso con bordo quadro 55x55 mm con o senza foro chiave Squared insert handle 55x55 mm with/without key hole	OTTONE LUCIDO VERNICIATO "OLV"	12		
		CROMO LUCIDO "OCR"	12		
		CROMO SATINATO "CRS"	12		
		BRONZO GRAFFIATO LUCIDO "OBG"	12		

ACCESSORI PER
SCORREVOLI

CODICE	DESCRIZIONE	FINITURE	IMBALLO	
203	Ditale per scorrevoli ø 29mm con bordo tondo	OTTONE LUCIDO VERNICIATO "OLV"	12	
		CROMO LUCIDO "OCR"	12	
	Finger pull ø 29 mm	CROMO SATINATO "CRS"	12	
	BRONZO GRAFFIATO LUCIDO "OBG"	12		
203/Q	Ditale per scorrevoli 21x21 mm con bordo quadro	OTTONE LUCIDO VERNICIATO "OLV"	12	
		CROMO LUCIDO "OCR"	12	
	Squared finger pull 21x21 mm	CROMO SATINATO "CRS"	12	
	BRONZO GRAFFIATO LUCIDO "OBG"	12		
222	Placca ad incasso quadra Lux 59x59 mm foro scasso 48 mm con labbro e foro sagomato mezza luna	OTTONE LUCIDO VERNICIATO "OLV"	6	
		CROMO LUCIDO "OCR"	6	
	Square insert handle 59x59 mm	CROMO SATINATO "CRS"	6	
	BRONZO GRAFFIATO LUCIDO "OBG"	6		
223	Placca ad incasso tonda Pesante ø 59 mm foro scasso 48 mm con labbro interno e cornice maggiorata	OTTONE LUCIDO VERNICIATO "OLV"	6	
		CROMO LUCIDO "OCR"	6	
	Round insert handle ø 59 mm	CROMO SATINATO "CRS"	6	
	BRONZO GRAFFIATO LUCIDO "OBG"	6		
224	Placca ad incasso tonda ø 59 scasso 48 mm con labbro e foro sagomato mezza luna	OTTONE LUCIDO VERNICIATO "OLV"	6	
		CROMO LUCIDO "OCR"	6	
	Round insert handle ø 59 mm	CROMO SATINATO "CRS"	6	
	BRONZO GRAFFIATO LUCIDO "OBG"	6		
971	Maniglioncino completo di kit per fissaggio			
		Pull handle Fixing system included	160 mm	
		OTTONE LUCIDO VERNICIATO "OLV"	12	
		CROMO SATINATO "CRS"	12	
		BRONZO GRAFFIATO LUCIDO "OBG"	12	
		200 mm		
		OTTONE LUCIDO VERNICIATO "OLV"	12	
	CROMO SATINATO "CRS"	12		
	BRONZO GRAFFIATO LUCIDO "OBG"	12		

ACCESSORI PER
SCORREVOLI

CODICE	DESCRIZIONE	FINITURE	IMBALLO	
350	<p>Maniglione alzante in ottone con placca incasso e kit di fissaggio</p> <p>Brass single pull handle for sliding door Closed plate Fixing system included</p> 	<p>OTTONE LUCIDO VERNICIATO "OLV" CROMO SATINATO "CRS" BRONZO GRAFFIATO LUCIDO "OBG"</p>	<p>1 1 1</p>	<p>OTTONE / BRASS</p> 
351	<p>Coppia di maniglioni alzanti foro yale in ottone con kit fissaggio</p> <p>Brass pair pull handles for sliding door Fixing system included</p> 	<p>OTTONE LUCIDO VERNICIATO "OLV" CROMO SATINATO "CRS" BRONZO GRAFFIATO LUCIDO "OBG"</p>	<p>1 1 1</p>	<p>OTTONE / BRASS</p> 
370	<p>Maniglione alzante quadro con placca incasso e kit di fissaggio</p> <p>Single pull handle for sliding door Closed plate Fixing system included</p> 	<p>CROMO LUCIDO "OCR" CROMO SATINATO "CRS" BIANCO "BNC" NERO "NE"</p>	<p>1 1 1 1</p>	<p>ZAMA / ZAMAK</p> 
371	<p>Coppia di maniglioni alzanti quadri foro yale con kit fissaggio</p> <p>Pair pull handles for sliding door Fixing system included</p> 	<p>CROMO LUCIDO "OCR" CROMO SATINATO "CRS" BIANCO "BNC" NERO "NE"</p>	<p>1 1 1 1</p>	<p>ZAMA / ZAMAK</p> 

**ALZANTI PER
SCORREVOLI**

CODICE	DESCRIZIONE	FINITURE	IMBALLO
520	Battente ad anello Door Knocker	<p>Ø 110 mm - rosone Ø 80 mm</p> <p>OTTONE LUCIDO PVD "PVD" 1 OTTONE LUCIDO VERNICIATO "OLV" 1 CROMO SATINATO "CRS" 1 BRONZO GRAFFIATO LUCIDO "OBG" 1</p> <p>Ø 130 mm - rosone Ø 80 mm</p> <p>OTTONE LUCIDO PVD "PVD" 1 OTTONE LUCIDO VERNICIATO "OLV" 1 CROMO SATINATO "CRS" 1 BRONZO GRAFFIATO LUCIDO "OBG" 1</p>	<p>OTTONE / BRASS</p> 

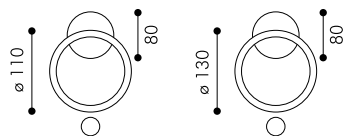

521	Battente Esagonale Door Knocker	<p>120x90 mm - rosone Ø 80 mm</p> <p>OTTONE LUCIDO VERNICIATO "OLV" 1 CROMO SATINATO "CRS" 1 BRONZO GRAFFIATO LUCIDO "OBG" 1</p>	<p>OTTONE / BRASS</p> 
------------	------------------------------------	---	---

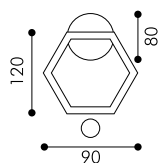

522	Battente Margherita Door Knocker	<p>Ø 115 mm - rosone Ø 75 mm</p> <p>OTTONE LUCIDO VERNICIATO "OLV" 1 BRONZO GRAFFIATO LUCIDO "OBG" 1 NIKEL NERO FERROANTICO "NA" 1</p> <p>Ø 120 mm - rosone Ø 80 mm</p> <p>OTTONE LUCIDO PVD "PVD" 1 OTTONE LUCIDO VERNICIATO "OLV" 1 CROMO SATINATO "CRS" 1 BRONZO GRAFFIATO LUCIDO "OBG" 1</p>	<p>OTTONE / BRASS</p> 
------------	-------------------------------------	---	---

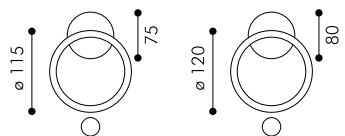

540	Battente Barocco Door Knocker	<p>120x100 mm - rosone Ø 80 mm</p> <p>OTTONE LUCIDO VERNICIATO "OLV" 1 BRONZO GRAFFIATO LUCIDO "OBG" 1</p>	<p>OTTONE / BRASS</p> 
------------	----------------------------------	--	---

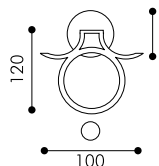

541	Battente Lira Door Knocker	<p>120x90 mm - rosone Ø 80 mm</p> <p>OTTONE LUCIDO PVD "PVD" 1 OTTONE LUCIDO VERNICIATO "OLV" 1</p>	<p>OTTONE / BRASS</p> 
------------	-------------------------------	---	---

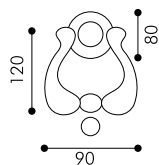

BATTENTI

SERIE TONDA



CODICE	DESCRIZIONE	FINITURE	IMBALLO
115	Set per porta blindata composto da: Maniglia Dolly ambidestra su rosetta \varnothing 50 mm Pomolo Sveden \varnothing 65 mm su rosetta \varnothing 50 mm Limitatore q.8 su rosetta \varnothing 50 mm Quadro 8 ad espansione da mm 65 Niples per fissaggio maniglia pomolo	OTTONE LUCIDO VERNICIATO "OLV" CROMO LUCIDO "OCR" CROMO SATINATO "CRS" BRONZO GRAFFIATO LUCIDO "OBG"	1 1 1 1
	Set security door		

SERIE QUADRA





CODICE	DESCRIZIONE	FINITURE	IMBALLO
215	Set per porta blindata composto da: Maniglia Quadra ambidestra su rosetta 50x50 mm Pomolo Quadra 60x60 mm su rosetta 50x50 mm Limitatore q.8 su rosetta 50x50 mm Quadro 8 ad espansione da mm 65 Niples per fissaggio maniglia pomolo	CROMO LUCIDO "OCR" CROMO SATINATO "CRS"	1 1
	Set security door		





OTTONE/ZAMA - BRASS/ZAMAK

ARTICOLI PER BLINDATI

SECURITY DOOR ARTICLES

CODICE	DESCRIZIONE	FINITURE	IMBALLO	
CPB/1	Corredo porta blindata composto da: Mostrina ovale 82x62 mm Rosetta a cappuccio copridefender Pomolino per cilindro con codolo da 8 mm Mostrina ovale 82x62 con foro 10 mm	OTTONE LUCIDO VERNICIATO "OLV" CROMO LUCIDO "OCR" CROMO SATINATO "CRS" BRONZO GRAFFIATO LUCIDO "OBG"	1 1 1 1	OTTONE / BRASS 
	Set security door Set disponibile per defender ø 46 mm e ø 50 mm			
CPB/2	Corredo porta blindata composto da: Mostrina ovale 82x62 mm Rosetta a cappuccio copridefender Mostrina ovale 82x62 mm con foro cilindro	OTTONE LUCIDO VERNICIATO "OLV" CROMO LUCIDO "OCR" CROMO SATINATO "CRS" BRONZO GRAFFIATO LUCIDO "OBG"	1 1 1 1	OTTONE / BRASS 
	Set security door Set disponibile per defender ø 46 mm e ø 50 mm			
SP/T	Spioncino base tonda stelo ø 14 mm estensione da 50 a 80 mm oppure estensione da 70 a 120 mm	EFFETTO OTTONE LUCIDO "OLV" EFFETTO CROMO SATINATO "ECSR" EFFETTO BRONZO "EOB"	10 10 10	ALLUMINIO / ALUMINIUM 
	Viewer			
CPB/Q1	Corredo porta blindata composto da: Mostrina rettangolare 75x62 mm Rosetta a cappuccio copridefender Pomolino per cilindro con codolo da 8 mm Mostrina rettangolare 75x62 mm con foro 10 mm	CROMO LUCIDO "OCR" CROMO SATINATO "CRS"	1 1	OTTONE / BRASS 
	Set security door Set disponibile per defender ø 48 mm e ø 50 mm			
CPB/Q2	Corredo porta blindata composto da: Mostrina rettangolare 75x62 mm Rosetta a cappuccio copridefender Mostrina rettangolare 75x62 mm con foro cilindro	CROMO LUCIDO "OCR" CROMO SATINATO "CRS"	1 1	OTTONE / BRASS 
	Set security door Set disponibile per defender ø 48 mm e ø 50 mm			
SP/Q	Spioncino base quadra stelo ø 14 mm estensione da 50 a 80 mm oppure estensione da 70 a 120 mm	EFFETTO OTTONE LUCIDO "OLV" CROMO LUCIDO "OCR" CROMO SATINATO "CRS"	1 1 1	ZAMA / ZAMAK 
	Viewer			

**ARTICOLI
PER BLINDATI**

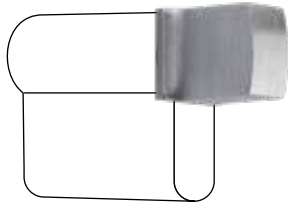
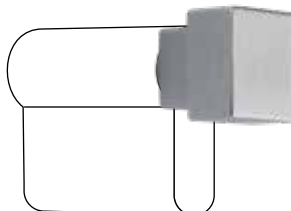
CODICE	DESCRIZIONE	FINITURE	IMBALLO	
R/RE/Y	Mostrina rettangolare 75x62 mm con sottoplastica con foro cilindro yale Escutcheon 75x62 mm yale	CROMO LUCIDO "OCR" CROMO SATINATO "CRS"	2 2	OTTONE / BRASS 
R/RE/DEF	Mostrina rettangolare 75x62 mm con sottoplastica per defender ø foro 48/50 Escutcheon 75x62 mm for defender	CROMO LUCIDO "OCR" CROMO SATINATO "CRS"	2 2	OTTONE / BRASS 
R/RE/10	Mostrina rettangolare 75x62 mm con sottoplastica con foro per codolo pomello cilindro Escutcheon 75x62 mm 10 mm hole	CROMO LUCIDO "OCR" CROMO SATINATO "CRS"	2 2	OTTONE / BRASS 
RM/Q5/10	Mostrina quadra 50x50 mm con sottoplastica con foro per codolo pomello cilindro Escutcheon 50x50 mm 10 mm hole	CROMO LUCIDO "OCR" CROMO SATINATO "CRS"	2 2	OTTONE / BRASS 
CIL/R	Pomello per cilindro tipo rettangolare foro 8 mm Cylinder knob 8 mm	CROMO LUCIDO "OCR" CROMO SATINATO "CRS"	8 8	ZAMA / ZAMAK 
CL/Q	Pomello per cilindro tipo quadro foro 8 mm Cylinder knob 8 mm	CROMO LUCIDO "OCR" CROMO SATINATO "CRS"	8 8	ZAMA / ZAMAK 

**ARTICOLI
PER BLINDATI**







CODICE	DESCRIZIONE	FINITURE	IMBALLO	
688	Limitatore di apertura a Farfalla con entrata per quadrello da 8 mm Rosetta ø 50 mm Diverter opening 8 mm for armored door. Rose ø 50 mm	OTTONE LUCIDO VERNICIATO "OLV"	12	ZAMA / ZAMAK 
		CROMO SATINATO "CRS"	12	
		BRONZO GRAFFIATO LUCIDO "OBG"	12	
682	Limitatore di apertura tondo con entrata per quadrello da 8 mm Rosetta ø 50 mm Diverter opening 8 mm for armored door. Rose ø 50 mm	OTTONE LUCIDO VERNICIATO "OLV"	8	ZAMA / ZAMAK 
		CROMO SATINATO "CRS"	8	
		BRONZO GRAFFIATO LUCIDO "OBG"	8	
982	Limitatore di apertura quadro con entrata per quadrello da 8 mm da 50x50 mm Diverter opening 8 mm for armored door. Rose 50x50 mm	CROMO LUCIDO "OCR"	3	ZAMA / ZAMAK 
		CROMO SATINATO "CRS"	3	
988	Limitatore di apertura rettangolare con entrata per quadrello da 8 mm da 50x50 mm Diverter opening 8 mm for armored door. Rose 50x50 mm	CROMO LUCIDO "OCR"	3	ZAMA / ZAMAK 
		CROMO SATINATO "CRS"	3	
R/OV/Y	Mostrina ovale 82x62 mm con sottoplastica con foro cilindro yale Oval escutcheon 82x62 mm yale	OTTONE LUCIDO VERNICIATO "OLV" CROMO LUCIDO "OCR" CROMO SATINATO "CRS" BRONZO GRAFFIATO LUCIDO "OBG"	4 4 4 4	OTTONE / BRASS 
R/OV/DEF	Mostrina ovale 82x62 mm con sottoplastica per defender foro ø 46/50 Oval escutcheon 82x62 mm for defender	OTTONE LUCIDO VERNICIATO "OLV" CROMO LUCIDO "OCR" CROMO SATINATO "CRS" BRONZO GRAFFIATO LUCIDO "OBG"	4 4 4 4	OTTONE / BRASS 

**ARTICOLI
PER BLINDATI**

CODICE	DESCRIZIONE	FINITURE	IMBALLO	
CAP	Rosetta a cappuccio copridefender misura 46/48/50 mm Cover for defender	OTTONE LUCIDO VERNICIATO "OLV" CROMO LUCIDO "OCR" CROMO SATINATO "CRS" BRONZO GRAFFIATO LUCIDO "OBG"	4 4 4 4	OTTONE / BRASS 
481	Pomello per cilindro tipo Farfalla foro ø 8 mm Cylinder knob 8mm	OTTONE LUCIDO VERNICIATO "OLV" CROMO LUCIDO "OCR" CROMO SATINATO "CRS" BRONZO GRAFFIATO LUCIDO "OBG"	4 4 4 4	ZAMA / ZAMAK 
431	Pomello per cilindro tipo tondo foro ø 8 mm Cylinder knob ø 8 mm	OTTONE LUCIDO VERNICIATO "OLV" CROMO LUCIDO "OCR" CROMO SATINATO "CRS" BRONZO GRAFFIATO LUCIDO "OBG"	4 4 4 4	OTTONE / BRASS 
441	Pomello per cilindro tipo lusso foro ø 8 mm Cylinder knob ø 8 mm	OTTONE LUCIDO VERNICIATO "OLV" CROMO LUCIDO "OCR" CROMO SATINATO "CRS" BRONZO GRAFFIATO LUCIDO "OBG"	4 4 4 4	OTTONE / BRASS 
R/OV/10	Mostrina ovale foro per pomello cilindro 82x62 mm con sottoplastica a pressione Oval escutcheon 82x62 mm with plastic support cylinder knob	OTTONE LUCIDO VERNICIATO "OLV" CROMO LUCIDO "OCR" CROMO SATINATO "CRS" BRONZO GRAFFIATO LUCIDO "OBG"	4 4 4 4	OTTONE / BRASS 
RM1/10	Rosetta tonda ø 45 mm con foro ø 10 mm per pomello cilindro Escutcheon ø 45 mm ø 10 mm hole	OTTONE LUCIDO VERNICIATO "OLV" CROMO LUCIDO "OCR" CROMO SATINATO "CRS" BRONZO GRAFFIATO LUCIDO "OBG"	4 4 4 4	OTTONE / BRASS 

**ARTICOLI
PER BLINDATI**

SECURITY DOOR ARTICLES

CODICE	DESCRIZIONE	FINITURE	IMBALLO	
720	Supporto corrimano base quadra Handrail support	OTTONE LUCIDO VERNICIATO "OLV" CROMO SATINATO "CRS" OTTONE BRONZATO "OB"	6 6 6	OTTONE / BRASS 
730	Supporto corrimano testa piana base tonda Handrail support	OTTONE LUCIDO VERNICIATO "OLV" CROMO SATINATO "CRS" OTTONE BRONZATO "OB"	6 6 6	OTTONE / BRASS 
740	Supporto corrimano testa piana con rosetta Handrail support with rose	OTTONE LUCIDO VERNICIATO "OLV" CROMO SATINATO "CRS" OTTONE BRONZATO "OB"	6 6 6	OTTONE / BRASS 
453	Chiave patent in ottone Brass Key	OTTONE LUCIDO VERNICIATO "OLV" CROMO SATINATO "CRS" OTTONE BRONZATO "OB" BRONZO ANTICO OPACO "ANT"	25 25 25 25	OTTONE / BRASS 
1909	Anello per portoncino con fissaggio passante troncone e dado ceco Door knoker	OTTONE LUCIDO VERNICIATO "OLV" OTTONE LUCIDO NON VERNICIATO "OLN" OTTONE INVECCHIATO PROTETTO "OIP" NIKEL NERO FERROANTICO "NA"	3 3 3	OTTONE / BRASS 
680	Tavellino a scatto Release flat handle	inc. mm 5 OTT. NATURALE "OL" inc. mm 10 OTT. NATURALE "OL" inc. mm 15 OTT. NATURALE "OL" inc. mm 20 OTT. NATURALE "OL" inc. mm 25 OTT. NATURALE "OL" inc. mm 30 OTT. NATURALE "OL"	24 24 24 24 24 24	OTTONE / BRASS 

BRONZATO +15% - CROMATO +25%

CODICE	DESCRIZIONE	FINITURE	IMBALLO	
1301/F	Ovalina su rosetta mm 38x64 ∅8mm fissa o girevole	OTTONE LUCIDO VERNICIATO "OLV"	8	OTTONE / BRASS 
		CROMO LUCIDO "OCR"	8	
		CROMO SATINATO "CRS"	8	
1301/S	Small window handle Oval rose ∅8 mm	OTTONE LUCIDO VERNICIATO "OLV"	8	OTTONE / BRASS 
		CROMO LUCIDO "OCR"	8	
		CROMO SATINATO "CRS"	8	
690	Catenaccio di sicurezza a cremagliera misure disponibili 60 mm - 80 mm	OTTONE NATURALE "OL"	3	OTTONE / BRASS 
		OTTONE BRONZATO "OBV"	3	
		CROMO SATINATO "CRS"	3	
		OTTONE INVECCHIATO PROTETTO "OIP"	3	
		Shutter stop		
300	Segretino Elegant quadro 6/7 mm Rosetta ovale mm 25x65	OTTONE LUCIDO VERNICIATO "OLV"	8	OTTONE / BRASS 
		CROMO SATINATO "CRS"	8	
		BRONZO GRAFFIATO LUCIDO "OBG"	8	
		NIKEL SATINATO "NKS"	8	
		Small window handle Elegant Oval rose 6/7 mm square spindle		
670	Gancio fermapersiane	inc. mm 60 OTT. NATURALE "OL"	24	OTTONE / BRASS 
		inc. mm 80 OTT. NATURALE "OL"	24	
		inc. mm 100 OTT. NATURALE "OL"	24	
		inc. mm 120 OTT. NATURALE "OL"	12	
		inc. mm 140 OTT. NATURALE "OL"	12	
		BRONZATO +15% - CROMATO +25%		
800	Cricchetto sopra luce con incontro tipo A / tipo B	OTTONE NATURALE "OL"	24	OTTONE / BRASS 
		CROMO LUCIDO "OCR"	24	
		OTTONE BRONZATO "OB"	24	
		Finger catch		
810	Pinza fermaporta con incontro tipo A / tipo B	OTTONE NATURALE "OL"	24	OTTONE / BRASS 
		CROMO LUCIDO "OCR"	24	
		OTTONE BRONZATO "OB"	24	
		Door stop keeper		

CODICE	DESCRIZIONE	FINITURE	IMBALLO
880			OTTONE / BRASS
	L C H		
	115 96 21	OTTONE LUCIDO VERNICIATO "OLV"	50
	115 96 21	OTTONE LUCIDO NON VERNICIATO "OLN"	50
	115 96 21	OTTONE SATINATO VERNICIATO "OSL"	50
	115 96 21	CROMO LUCIDO "OCR"	50
	115 96 21	CROMO SATINATO "CRS"	50
	115 96 21	BRONZO GRAFFIATO LUCIDO "OBG"	50
	115 96 21	NIKEL SATINATO "NKS"	50
	150 128 28	OTTONE LUCIDO VERNICIATO "OLV"	24
	150 128 28	OTTONE LUCIDO NON VERNICIATO "OLN"	24
	150 128 28	OTTONE SATINATO VERNICIATO "OSL"	24
	150 128 28	CROMO LUCIDO "OCR"	24
	150 128 28	CROMO SATINATO "CRS"	24
	150 128 28	BRONZO GRAFFIATO LUCIDO "OBG"	24
	150 128 28	NIKEL SATINATO "NKS"	24



885				ZAMA / ZAMAK
	L C H			
	125 96 26	CROMO SATINATO "CRS"	24	
	158 128 29	CROMO SATINATO "CRS"	24	



945				ZAMA / ZAMAK
	L C H			
	120 96 25	CROMO LUCIDO "OCR"	24	
	120 96 25	CROMO SATINATO "CRS"	24	
	152 128 25	CROMO LUCIDO "OCR"	24	
	152 128 25	CROMO SATINATO "CRS"	24	



955				ZAMA / ZAMAK
	L C H			
	102 96 25	CROMO LUCIDO "OCR"	24	
	102 96 25	CROMO SATINATO "CRS"	24	
	134 128 25	CROMO LUCIDO "OCR"	24	
	134 128 25	CROMO SATINATO "CRS"	24	



965				ZAMA / ZAMAK
	L C H			
	77 64 18	ARGENTO VECCHIO "NA"	24*	
	110 96 24	ARGENTO VECCHIO "NA"	24*	



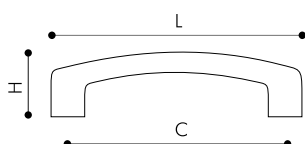

* quantità minima tassativa







**MANIGLIETTE
PER MOBILI**

FURNITURE HANDLES

CODICE	DESCRIZIONE	FINITURE	IMBALLO	
BFC/1	Bocchetta con inserto plastica ø 45 mm			
	Escutcheon with plastic insert ø 45 mm	OTTONE LUCIDO VERNICIATO "OLV"	24	
		CROMO LUCIDO "OCR"	24	
		CROMO SATINATO "CRS"	24	
		BRONZO GRAFFIATO LUCIDO "OBG"	24	
		NIKEL SATINATO "NKS"	24	<i>nella foto: foro patent disponibili anche: foro yale doppia mappa - cieche</i>
BFC/2	Bocchetta con inserto plastica ø 50 mm			
	Escutcheon with plastic insert ø 50 mm	OTTONE LUCIDO VERNICIATO "OLV"	24	
		CROMO LUCIDO "OCR"	24	
		CROMO SATINATO "CRS"	24	
		BRONZO GRAFFIATO LUCIDO "OBG"	24	
		NIKEL SATINATO "NKS"	24	<i>nella foto: foro patent disponibili anche: foro yale</i>
BFC/3	Bocchetta piana a vitare ø 50 mm			
	Escutcheon with brass base ø 50 mm	OTTONE LUCIDO VERNICIATO "OLV"	24	
		CROMO LUCIDO "OCR"	24	
		CROMO SATINATO "CRS"	24	
		BRONZO GRAFFIATO LUCIDO "OBG"	24	
		NIKEL SATINATO "NKS"	24	<i>nella foto: foro patent disponibili anche: foro yale doppia mappa</i>
BFC/3B	Bocchetta bombata a vitare ø 50 mm			
	Escutcheon with curved brass base ø 50 mm	OTTONE LUCIDO VERNICIATO "OLV"	24	
		CROMO LUCIDO "OCR"	24	
		CROMO SATINATO "CRS"	24	
		BRONZO GRAFFIATO LUCIDO "OBG"	24	
		NIKEL SATINATO "NKS"	24	<i>nella foto: foro patent disponibili anche: foro yale doppia mappa</i>
BFC/4	Bocchetta con inserto plastica bicolore ø 50 mm			
	Escutcheon bicolor with plastic insert ø 50 mm	OTTONE LUCIDO VERNICIATO "OLV"	24	
		CROMO LUCIDO "OCR"	24	
		NIKEL SATINATO "NKS"	24	
				<i>nella foto: foro patent disponibili anche: foro yale</i>
BFC/5	Bocchetta Stile ø 45 mm fori in vista			
	Escutcheon Stile ø 45 mm	OTTONE LUCIDO VERNICIATO "OLV"	24	
				<i>nella foto: foro patent disponibili anche: foro yale cieche</i>

CODICE	DESCRIZIONE	FINITURE	IMBALLO	
BFC/6	Bocchetta ovale 40x65 mm fori in vista			 <p>nella foto: foro patent disponibili anche: foro yale - cieche</p>
	Oval escutcheon 40x65 mm	OTTONE LUCIDO VERNICIATO "OLV"	24	
		CROMO LUCIDO "OCR"	24	
		CROMO SATINATO "CRS"	24	
		BRONZO GRAFFIATO LUCIDO "OBG"	24	
	NIKEL SATINATO "NKS"	24		
BFC/7	Bocchetta ovale coprivite 32x62 mm			 <p>nella foto: foro patent disponibili anche: foro yale</p>
	Oval screw cover escutcheon 32x62 mm	OTTONE LUCIDO VERNICIATO "OLV"	24	
		CROMO LUCIDO "OCR"	24	
		CROMO SATINATO "CRS"	24	
		BRONZO GRAFFIATO LUCIDO "OBG"	24	
	NIKEL SATINATO "NKS"	24		
BFC/Q50	Bocchetta quadra 50x50 mm			 <p>nella foto: foro patent disponibili anche: foro yale doppia mappa - cieche</p>
	Square escutcheon 50x50 mm	CROMO LUCIDO "OCR"	24	
		CROMO SATINATO "CRS"	24	
BFC/Q45	Bocchetta quadra 45x45 mm			 <p>nella foto: foro patent disponibili anche: foro yale</p>
	Square escutcheon 45x45 mm	CROMO LUCIDO "OCR"	24	
		CROMO SATINATO "CRS"	24	
BFC/R1	Bocchetta rettangolare 32x62 mm			 <p>nella foto: foro patent disponibili anche: foro yale</p>
	Rectangular escutcheon 32x62 mm	CROMO LUCIDO "OCR"	24	
		CROMO SATINATO "CRS"	24	
BFC/DM1	Bocchetta rettangolare 46x60 mm fori in vista			 <p>nella foto: doppia mappa disponibili anche: foro yale</p>
	Duble bit escutcheon	OTTONE LUCIDO VERNICIATO "OLV"	24	
		CROMO LUCIDO "OCR"	24	
		CROMO SATINATO "CRS"	24	
		BRONZO GRAFFIATO LUCIDO "OBG"	24	
	NIKEL SATINATO "NKS"	24		

CODICE	DESCRIZIONE	FINITURE	IMBALLO	
601	Copriavvolgitore 278x56 mm angolo tondo			OTTONE / BRASS
	Rolling rape cover	OTTONE LUCIDO VERNICIATO "OLV" CROMO LUCIDO "OCR" CROMO SATINATO "CRS" BRONZO GRAFFIATO LUCIDO "OBG" NIKEL SATINATO "NKS"	14 14 14 14 14	
611	Copriavvolgitore 240x53 mm angolo quadro			OTTONE / BRASS
	Rolling squared rape cover	OTTONE LUCIDO VERNICIATO "OLV" CROMO LUCIDO "OCR" CROMO SATINATO "CRS" BRONZO GRAFFIATO LUCIDO "OBG" NIKEL SATINATO "NKS"	14 14 14 14 14	
630	Guida cinghia			OTTONE / BRASS
	Roller guide	OTTONE LUCIDO VERNICIATO "OLV" CROMO SATINATO "CRS" BRONZO GRAFFIATO LUCIDO "OBG"	12 12 12	
710	Bucalettere con molla 257x75 mm			OTTONE / BRASS
	Letter box plate 257x75 mm	OTTONE LUCIDO VERNICIATO "OLV" CROMO SATINATO "CRS" BRONZO GRAFFIATO LUCIDO "OBG"	1 1 1	
700	Bucalettere a cadenza 257x75 mm			OTTONE / BRASS
	Letter box plate 257x75 mm	OTTONE LUCIDO VERNICIATO "OLV" CROMO SATINATO "CRS" BRONZO GRAFFIATO LUCIDO "OBG"	1 1 1	
460	Chiocciola fermaporta			ZAMA / ZAMAK
	Door stopper	OTTONE LUCIDO VERNICIATO "OLV" CROMO LUCIDO "OCR" CROMO SATINATO "CRS" BRONZO GRAFFIATO LUCIDO "OBG" NIKEL SATINATO "NKS"	12* 12* 12* 12* 12*	
		* quantità minima tassativa		
461	Fermaporta a cilindro 36x28 mm			ZAMA / ZAMAK
	Door stopper 36x28 mm	OTTONE LUCIDO VERNICIATO "OLV" CROMO LUCIDO "OCR" CROMO SATINATO "CRS" BRONZO GRAFFIATO LUCIDO "OBG" NIKEL SATINATO "NKS"	12* 12* 12* 12* 12*	
		* quantità minima tassativa		

ACCESSORI

ACCESSORIES

CODICE DESCRIZIONE IMBALLO

MECCANISMI DRY KEEP PER FINESTRE ANTA RIBALTA

MOV/DK/1	Movimento DK 7x42 mm in metallo - 4 scatti	20
MOV/DK/4	Movimento DK 7x50 mm in metallo - 4 o 8 scatti	20
MOV/DK/3	Movimento DK in plastica ATP - 4 scatti	20



ALTRI ACCESSORI PER MONTAGGIO

XQUADRO	Quadro ad espansione 8x65 mm	10
XQUADRO/80	Quadro ad espansione 8x80 mm	10
Q8/1	Quadrello da 8x105 mm standard	20
Q7/1	Quadrello da 7x105 mm	20
Q6/1	Quadrello da 6x105 mm	20
Q8/CAMBIO/130	Quadro 8 snodato 130 mm + 30 mm	4
NIPLES/90	Quadro 8x90 mm + Filetto M14	4
NIPLES/120	Quadro 8x120 mm + Filetto M14	4
NIPLES/130	Quadro 8x130 mm + Filetto M14	4
NIPLES/90/M10	Quadro 8x90 mm + Filetto M10	4
NIPLES/120/M10	Quadro 8x120 mm + Filetto M10	4



DUMMY/Q8	Piastrina di fissaggio con Quadro	15
DUMMY/M10	Piastrina di fissaggio con Filetto M10	15



ACCESSORI

ACCESSORIES

CODICE	DESCRIZIONE	IMBALLO
--------	-------------	---------

**MECCANISMI "MOVIMENTI" PER MANIGLIE DA FINESTRA
TIPOLOGIA LUSO PER PLACCHE COPRIVATE**

MOV/GGB/1

Movimento Graz con bussole

4

**MOV/GGF/1**

Movimento Graz con fori

4

**MOV/G7/1**

Graz con fori + Q7 "tre chiusure"

4

**MOV/MP/1**

Movimento tipo MP

4

**MOV/GGP/1**

Movimento Graz con perni

4

**ACCESSORI**

ACCESSORIES

CODICE DESCRIZIONE IMBALLO

**MECCANISMI "MOVIMENTI" PER MANIGLIE DA FINESTRA
TIPOLOGIA ECONOMICI PER PLACCA CON FORI VITI A VISTA**

MOV/GGB/3	Movimento Graz con bussole	6	
MOV/GGF/2	Movimento Graz con fori	6	
MOV/GG7/4	Graz con fori + Q7 "tre chiusure"	6	
MOV/GP/3	Movimento Graz con perni	6	

ACCESSORI

ACCESSORIES

LINEA INOX
INOX LINE



INOX aisi 304

QUADRA

CODICE	DESCRIZIONE	FINITURE	IMBALLO
196	Guarnitura su rosetta e bocchetta \varnothing 50 mm con molla base in plastica Pair spring handles. Roses \varnothing 50 mm Plastic base	INOX SATINATO	1
196/OV	Guarnitura su rosetta rettangolare 30x60 mm Pair spring handles. Rectangular roses 30x60 mm	INOX SATINATO	1
196/DK	Impugnatura con movimento DK e rosetta 30x65 mm Handle DK. Rose 30x65 mm	INOX SATINATO	2

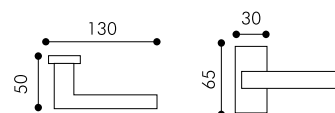
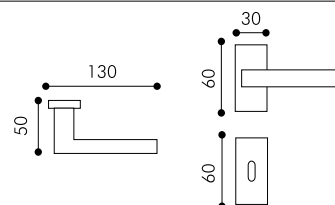
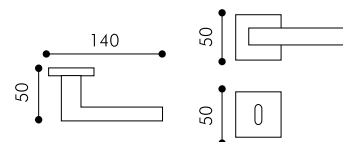

INOX aisi 304

BIG LEVA

CODICE	DESCRIZIONE	FINITURE	IMBALLO
136	Guarnitura su rosetta e bocchetta \varnothing 52 mm tonda con molla base in plastica Pair spring handles. Roses \varnothing 52 mm	INOX SATINATO	1
136/OV	Guarnitura su rosetta e bocchetta ovale 30x60 mm Pair spring handles. Oval roses 30x60 mm	INOX SATINATO	1

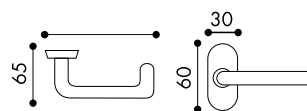
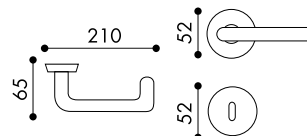



AMBRA

INOX aisi 304

CODICE	DESCRIZIONE	FINITURE	IMBALLO
176	Guarnitura su rosetta e bocchetta ø 50 mm tonda con molla base in plastica Pair spring handles. Roses ø 50 mm Plastic base	INOX SATINATO	1
176/OV	Guarnitura su rosetta e bocchetta ovale 30x60 mm Pair spring handles. Oval roses 30x60 mm	INOX SATINATO	1
176/DK	Impugnatura con movimento DK e rosetta 30x65 mm Handle DK. Rose 30x65 mm	INOX SATINATO	2

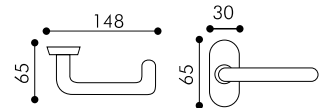
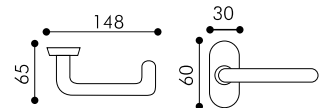
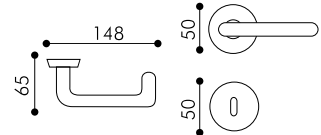

ELLISSE

INOX aisi 304

CODICE	DESCRIZIONE	FINITURE	IMBALLO
186	Guarnitura su rosetta e bocchetta ø 50 mm tonda con molla base in plastica Pair spring handles. Roses ø 50 mm Plastic base	INOX SATINATO	1
186/OV	Guarnitura su rosetta e bocchetta ovale 30x60 mm Pair spring handles. Oval roses 30x60 mm	INOX SATINATO	1
186/DK	Impugnatura con movimento DK e rosetta 30x65 mm Handle DK. Rose 30x65 mm	INOX SATINATO	2

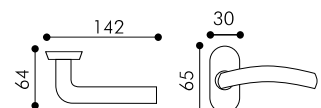
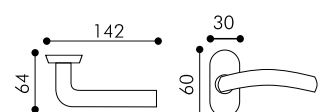
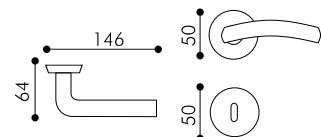

INOX aisi 304

GIRO

CODICE	DESCRIZIONE	FINITURE	IMBALLO
146	Guarnitura su rosetta e bocchetta ø 52 mm tonda con molla Pair spring handles. Roses ø 52 mm	INOX SATINATO	1
146/OV	Guarnitura su rosetta e bocchetta ovale 30x60 mm Pair spring handles. Oval roses 30x60 mm	INOX SATINATO	1
146/DK	Impugnatura con movimento DK e rosetta 30x65 mm Handle DK. Rose 30x65 mm	INOX SATINATO	2

INOX aisi 304

CORNER

CODICE	DESCRIZIONE	FINITURE	IMBALLO
266	Guarnitura su rosetta e bocchetta ø 52 mm tonda con molla Pair spring handles. Roses ø 52 mm	INOX SATINATO	1
266/OV	Guarnitura su rosetta e bocchetta ovale 30x60 mm Pair spring handles. Oval roses 30x60 mm	INOX SATINATO	1
266/DK	Impugnatura con movimento DK e rosetta 30x65 mm Handle DK. Rose 30x65 mm	INOX SATINATO	2



TUCANA

INOX aisi 304

CODICE	DESCRIZIONE	FINITURE	IMBALLO
156	Guarnitura su rosetta e bocchetta ø 50 mm tonda con molla Pair spring handles. Roses ø 50 mm	INOX BICOLOR	1
156/OV	Guarnitura su rosetta e bocchetta ovale 30x60 mm Pair spring handles. Oval roses 30x60 mm	INOX BICOLOR	1
156/DK	Impugnatura con movimento DK e rosetta 30x65 mm Handle DK. Rose 30x65 mm	INOX BICOLOR	2

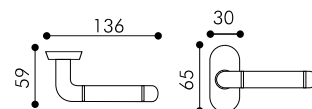
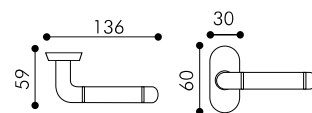
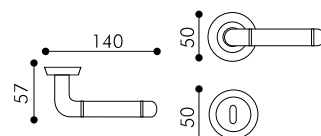





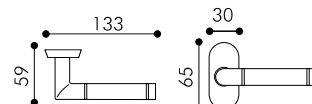
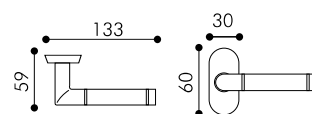
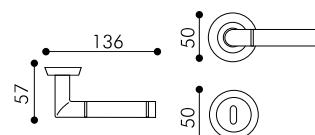

APUS

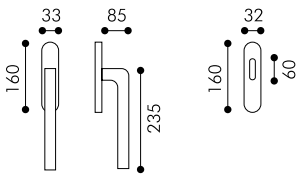
INOX aisi 304

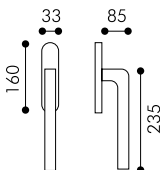
CODICE	DESCRIZIONE	FINITURE	IMBALLO
166	Guarnitura su rosetta e bocchetta ø 50 mm tonda con molla Pair spring handles. Roses ø 50 mm	INOX BICOLOR	1
166/OV	Guarnitura su rosetta e bocchetta ovale 30x60 mm Pair spring handles. Oval roses 30x60 mm	INOX BICOLOR	1
166/DK	Impugnatura con movimento DK e rosetta 30x65 mm Handle DK. Rose 30x65 mm	INOX BICOLOR	2









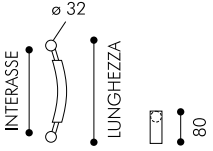

CODICE	DESCRIZIONE	FINITURE	IMBALLO	
360	<p>Maniglione alzante inox ø 20 mm con placca incasso e kit di fissaggio</p> <p>Inox single pull handle ø 20 mm for sliding door Closed plate Fixing system included</p> 	INOX SATINATO	1	
361	<p>Coppia di maniglioni alzanti inox ø 20 mm con foro yale con kit fissaggio</p> <p>Inox pair pull handles ø 20 mm for sliding door Fixing system included</p> 	INOX SATINATO	1	
125	<p>Pomolo cilindro ø 52 mm montaggio esterno con rosetta e accessori fissaggio</p> <p>Cylinder pull knob ø 52 mm Fixing system included</p>	INOX SATINATO	2	
135	<p>Pomolo sfera ø 50 mm montaggio esterno con rosetta</p> <p>Spherical pull knob ø 50 mm</p>	INOX SATINATO	2	

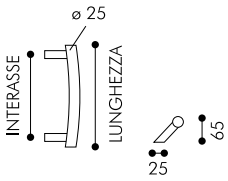
INOX aisi 304

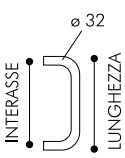
**ALZANTI E
POMOLI**

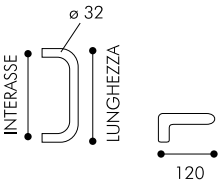
KNOBS AND SLIDING SET ACCESSORIES

CODICE	DESCRIZIONE			FINITURE	IMBALLO
MAN/011	<p>Maniglione inox diritto ø 32 mm senza rosette con kit di fissaggio</p> <p>Pull handle round ø 32 mm Inox without roses fixing system included</p>	Lunghezza	Interasse		
		432	400	INOX BICOLOR	1
		532	500	INOX BICOLOR	1
					
MAN/017	<p>Maniglione inox zancato ø 25 mm senza rosette con kit di fissaggio</p> <p>Pull handle round ø 25 mm Inox without roses fixing system included</p>	Lunghezza	Interasse		
		400	250	INOX BICOLOR	1
		500	350	INOX BICOLOR	1
					
MAN/001	<p>Maniglione inox diritto ø 32 mm senza rosette con kit di fissaggio</p> <p>Pull handle round ø 32 mm Inox without roses fixing system included</p>	Lunghezza	Interasse		
		382	350	INOX SATINATO	1
					
MAN/002	<p>Maniglione inox zancato ø 32 mm senza rosette con kit di fissaggio</p> <p>Pull handle round ø 32 mm Inox without roses fixing system included</p>	Lunghezza	Interasse		
		382	350	INOX SATINATO	1
					

MANIGLIONI INOX aisi 304

PULL HANDLES

CODICE	DESCRIZIONE	FINITURE	IMBALLO
MAN/015	<p>Maniglione bombato diritto con frontale 40x10 mm Acciaio inox senza rosette con kit di fissaggio</p> <p>Pull handle 40x10 mm Inox without roses fixing system included</p>	<p>Lunghezza Interasse</p> <p>600 400</p> <p>INOX SATINATO</p>	1
			
MAN/014	<p>Maniglione zancato con frontale 40x10 mm Acciaio inox senza rosette con kit di fissaggio</p> <p>Pull handle 40x10 mm Inox without roses fixing system included</p>	<p>Lunghezza Interasse</p> <p>600 400</p> <p>INOX SATINATO</p>	1
			
MAN/004	<p>Maniglione diritto con frontale 40X10 mm Acciaio inox senza rosette con kit di fissaggio</p> <p>Pull handle 40x10 mm Inox without roses fixing system included</p>	<p>Lunghezza Interasse</p> <p>600 400 800 600</p> <p>INOX SATINATO INOX SATINATO</p>	1 1
			

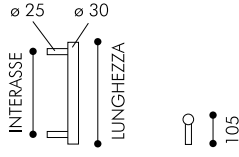
CODICE	DESCRIZIONE			FINITURE	IMBALLO
MAN/006B	<p>Maniglione diritto tondo ø 30 mm Acciaio inox senza rosette con kit di fissaggio</p> <p>Pull handle round ø 30 mm Inox without roses fixing system included</p> 	Lunghezza	Interasse		
		300	210	INOX SATINATO	1
		500	300	INOX SATINATO	1
		800	600	INOX SATINATO	1
		1200	900	INOX SATINATO	1

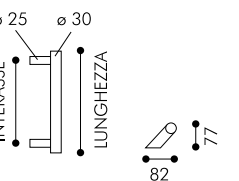

MAN/006A	<p>Maniglione zancato tondo ø 30 mm Acciaio inox senza rosette con kit di fissaggio</p> <p>Pull handle round ø 30 mm Inox without roses fixing system included</p> 	Lunghezza	Interasse		
		300	210	INOX SATINATO	1
		500	300	INOX SATINATO	1
		800	600	INOX SATINATO	1
		1200	900	INOX SATINATO	1

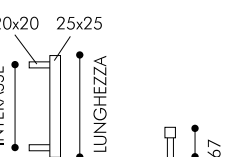

MAN/006SB	<p>Maniglione diritto quadro 25x25 mm Acciaio inox senza rosette con kit di fissaggio</p> <p>Pull handle square 25x25 mm Inox without roses fixing system included</p> 	Lunghezza	Interasse		
		300	210	INOX SATINATO	1
		500	300	INOX SATINATO	1
		800	600	INOX SATINATO	1
		1200	900	INOX SATINATO	1



MAN/006SA	<p>Maniglione zancato quadro 25x25 mm Acciaio inox senza rosette con kit di fissaggio</p> <p>Pull handle square 25x25 mm Inox without roses fixing system included</p> 	Lunghezza	Interasse		
		400	300	INOX SATINATO	1
		600	400	INOX SATINATO	1
		1200	900	INOX SATINATO	1



MANIGLIONI INOX aisi 304

PULL HANDLES

LINEA ATELIER
ATELIER LINE



Le Tonalità dell'ottone



Ottone lucido naturale **OLN**



Ottone lucido verniciato **OLV**



Ottone invecchiato protetto **OIP**



Ottone opaco **OVI**



Ottone ferroantico **NA**



Ottone ad effetto ruggine **ORG**



Ottone gradualmente modificato **OGM**

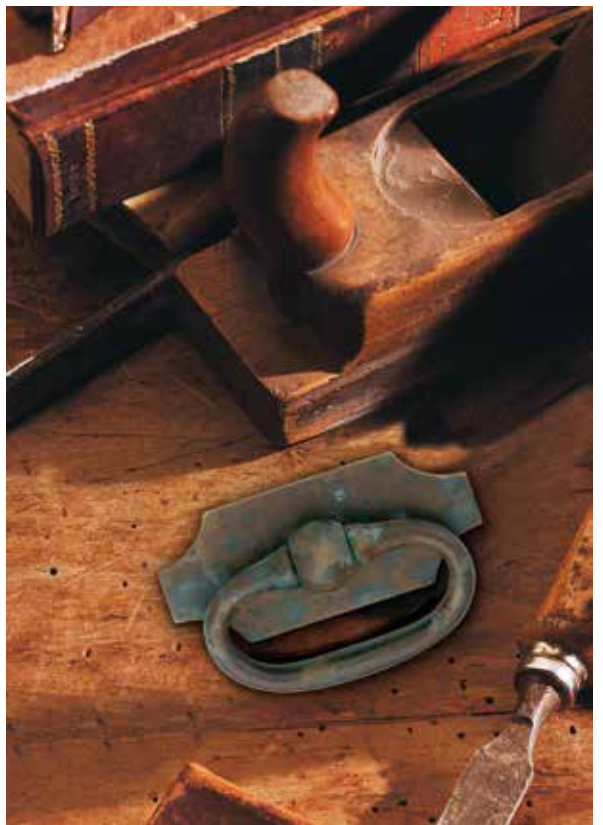

Invecchiato verde rame **IVR**

Stile

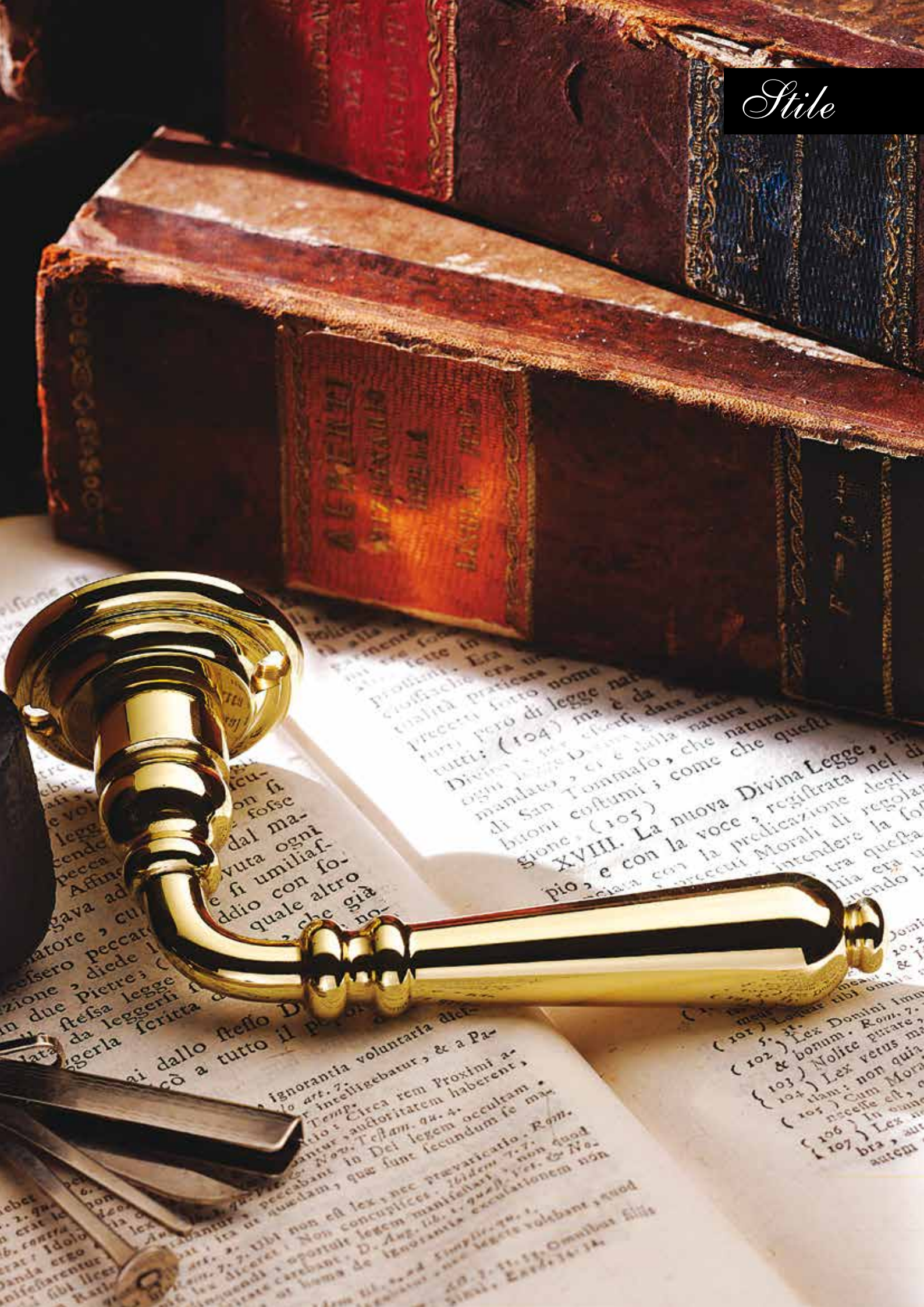

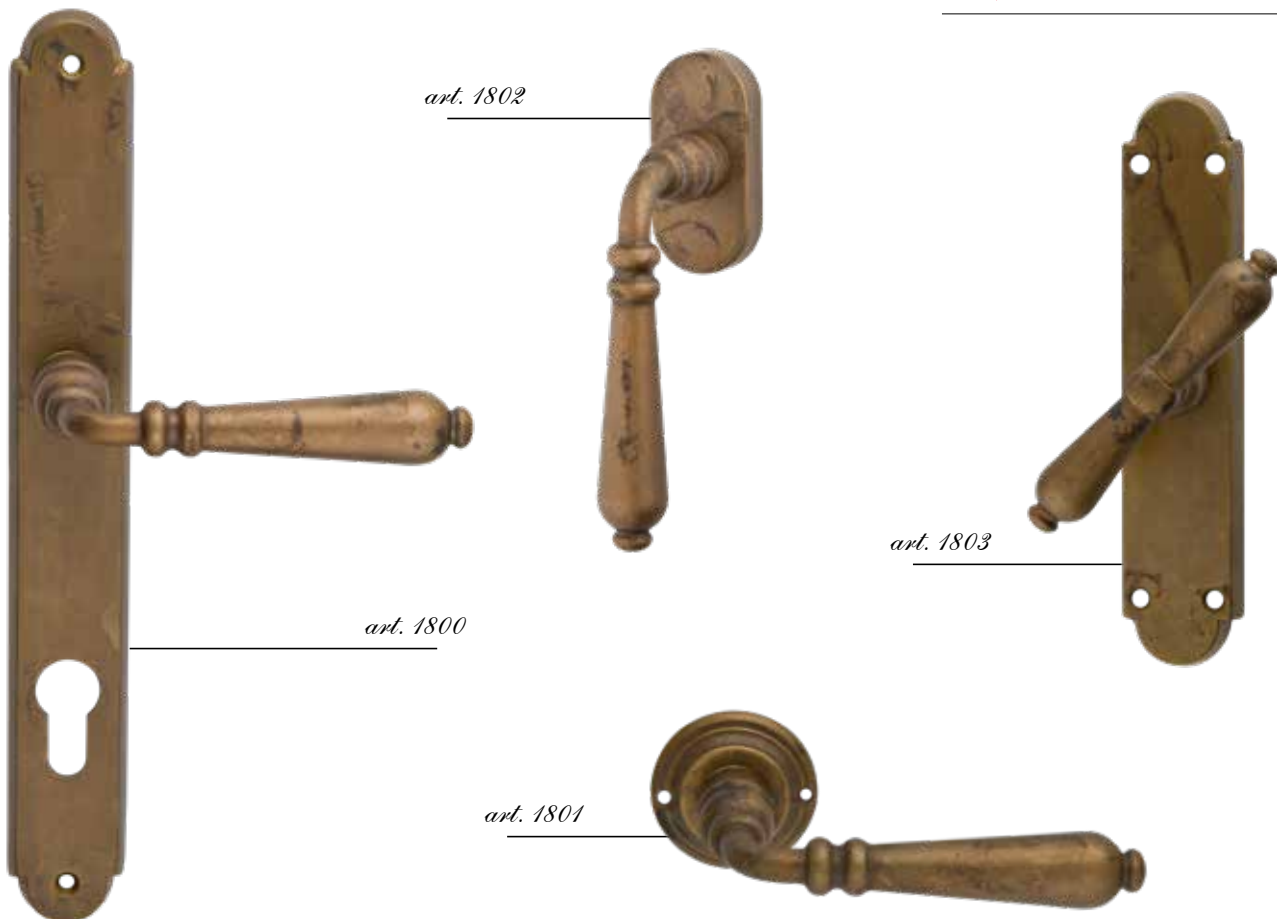

CODICE DESCRIZIONE FINITURE IMBALLO

1800	Guarnitura su placca	OTTONE LUCIDO VERNICIATO "OLV"	1	
		OTTONE LUCIDO NON VERNICIATO "OLN"	1	
		OTTONE NATURALE OPACO "OVI"	1	
		OTTONE INVECCHIATO PROTETTO "OIP"	1	
		NIKEL NERO FERROANTICO "NA"	1	
1801	Guarnitura su rosetta	OTTONE LUCIDO VERNICIATO "OLV"	1	
		OTTONE LUCIDO NON VERNICIATO "OLN"	1	
		OTTONE NATURALE OPACO "OVI"	1	
		OTTONE INVECCHIATO PROTETTO "OIP"	1	
		NIKEL NERO FERROANTICO "NA"	1	
1802	Maniglia per finestra anta ribalta - DK	OTTONE LUCIDO VERNICIATO "OLV"	2	
		OTTONE LUCIDO NON VERNICIATO "OLN"	2	
		OTTONE NATURALE OPACO "OVI"	2	
		OTTONE INVECCHIATO PROTETTO "OIP"	2	
		NIKEL NERO FERROANTICO "NA"	2	
1803	Cremonese per finestra	OTTONE LUCIDO VERNICIATO "OLV"	1	
		OTTONE LUCIDO NON VERNICIATO "OLN"	1	
		OTTONE NATURALE OPACO "OVI"	1	
		OTTONE INVECCHIATO PROTETTO "OIP"	1	
		NIKEL NERO FERROANTICO "NA"	1	



OLV



OLN



OVI



OIP



NA

Stile

Toscana





art. 1452



art. 1453



art. 1450

art. 1451



CODICE	DESCRIZIONE	FINITURE	IMBALLO	
1450	Guarnitura su placca	OTTONE LUCIDO VERNICIATO "OLV" OTTONE LUCIDO NON VERNICIATO "OLN" OTTONE NATURALE OPACO "OVI" OTTONE INVECCHIATO PROTETTO "OIP"	1 1 1 1	
1451	Guarnitura su rosetta	OTTONE LUCIDO VERNICIATO "OLV" OTTONE LUCIDO NON VERNICIATO "OLN" OTTONE NATURALE OPACO "OVI" OTTONE INVECCHIATO PROTETTO "OIP"	1 1 1 1	
1452	Maniglia per finestra anta ribalta - DK	OTTONE LUCIDO VERNICIATO "OLV" OTTONE LUCIDO NON VERNICIATO "OLN" OTTONE NATURALE OPACO "OVI" OTTONE INVECCHIATO PROTETTO "OIP"	2 2 2 2	
1453	Cremonese per finestra	OTTONE LUCIDO VERNICIATO "OLV" OTTONE LUCIDO NON VERNICIATO "OLN" OTTONE NATURALE OPACO "OVI" OTTONE INVECCHIATO PROTETTO "OIP"	2 2 2 2	



Antiqua



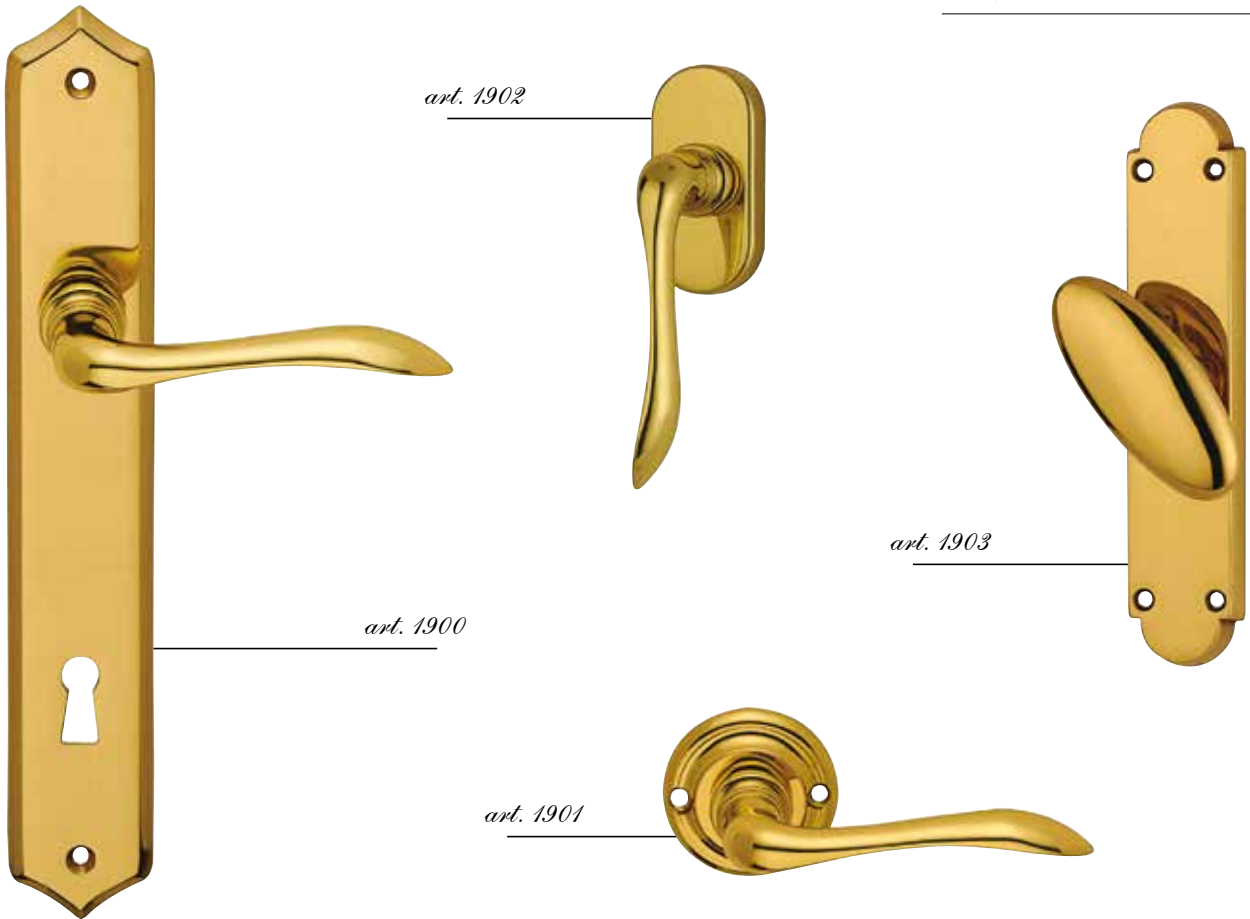

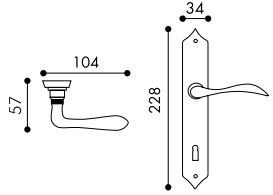
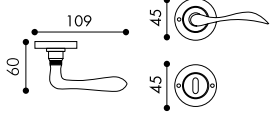
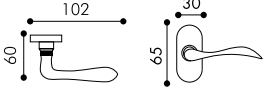
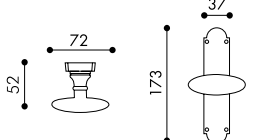
CODICE	DESCRIZIONE	FINITURE	IMBALLO
1900	Guarnitura su placca	OTTONE LUCIDO VERNICIATO "OLV" OTTONE LUCIDO NON VERNICIATO "OLN" OTTONE INVECCHIATO PROTETTO "OIP" NIKEL NERO FERROANTICO "NA"	1 1 1 1 
1901	Guarnitura su rosetta	OTTONE LUCIDO VERNICIATO "OLV" OTTONE LUCIDO NON VERNICIATO "OLN" OTTONE INVECCHIATO PROTETTO "OIP" NIKEL NERO FERROANTICO "NA"	1 1 1 1 
1902	Maniglia per finestra anta ribalta - DK	OTTONE LUCIDO VERNICIATO "OLV" OTTONE LUCIDO NON VERNICIATO "OLN" OTTONE INVECCHIATO PROTETTO "OIP" NIKEL NERO FERROANTICO "NA"	2 2 2 2 
1903	Cremonese per finestra	OTTONE LUCIDO VERNICIATO "OLV" OTTONE LUCIDO NON VERNICIATO "OLN" OTTONE INVECCHIATO PROTETTO "OIP" NIKEL NERO FERROANTICO "NA"	1 1 1 1 



Rustica



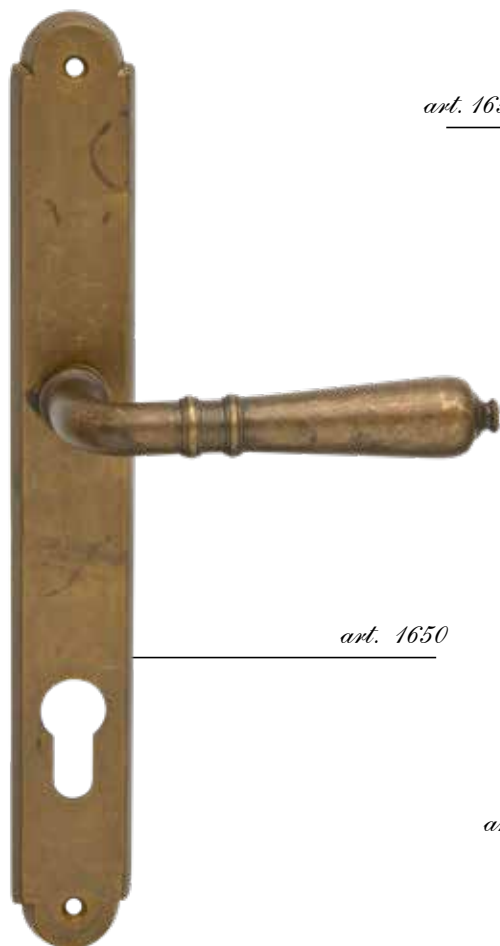

art. 1650

art. 1652



art. 1653



art. 1651



CODICE DESCRIZIONE FINITURE IMBALLO

1650

Guarnitura su placca

OTTONE LUCIDO VERNICIATO "OLV" 1
 OTTONE LUCIDO NON VERNICIATO "OLN" 1
 OTTONE NATURALE OPACO "OVI" 1
 OTTONE INVECCHIATO PROTETTO "OIP" 1

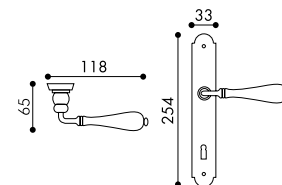

1651

Guarnitura su rosetta

OTTONE LUCIDO VERNICIATO "OLV" 1
 OTTONE LUCIDO NON VERNICIATO "OLN" 1
 OTTONE NATURALE OPACO "OVI" 1
 OTTONE INVECCHIATO PROTETTO "OIP" 1

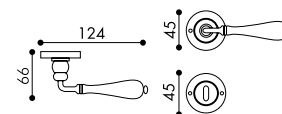

1652

Maniglia per finestra
 anta ribalta - DK

OTTONE LUCIDO VERNICIATO "OLV" 2
 OTTONE LUCIDO NON VERNICIATO "OLN" 2
 OTTONE NATURALE OPACO "OVI" 2
 OTTONE INVECCHIATO PROTETTO "OIP" 2

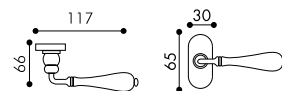

1653

Cremonese per finestra

OTTONE LUCIDO VERNICIATO "OLV" 1
 OTTONE LUCIDO NON VERNICIATO "OLN" 1
 OTTONE NATURALE OPACO "OVI" 1
 OTTONE INVECCHIATO PROTETTO "OIP" 1

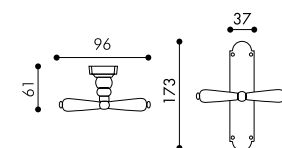

OLV

OLN

OVI

OIP

NA

(PREZZI INDICATI)

(extra + 20%)

Rustica



Pressburg





CODICE	DESCRIZIONE	FINITURE	IMBALLO
5070	Guarnitura su placca	OTTONE LUCIDO VERNICIATO "OLV" OTTONE LUCIDO NON VERNICIATO "OLN" OTTONE INVECCHIATO PROTETTO "OIP" NIKEL NERO FERROANTICO "NA" EFFETTO RUGGINE "ORG"	1 1 1 1 1
5071/f	Guarnitura su rosetta	OTTONE LUCIDO VERNICIATO "OLV" OTTONE LUCIDO NON VERNICIATO "OLN" OTTONE INVECCHIATO PROTETTO "OIP" NIKEL NERO FERROANTICO "NA" EFFETTO RUGGINE "ORG"	1 1 1 1 1
5072	Maniglia per finestra anta ribalta - DK	OTTONE LUCIDO VERNICIATO "OLV" OTTONE LUCIDO NON VERNICIATO "OLN" OTTONE INVECCHIATO PROTETTO "OIP" NIKEL NERO FERROANTICO "NA" EFFETTO RUGGINE "ORG"	2 2 2 2 2
5073	Cremonese per finestra	OTTONE LUCIDO VERNICIATO "OLV" OTTONE LUCIDO NON VERNICIATO "OLN" OTTONE INVECCHIATO PROTETTO "OIP" NIKEL NERO FERROANTICO "NA" EFFETTO RUGGINE "ORG"	1 1 1 1 1



Maniglioni



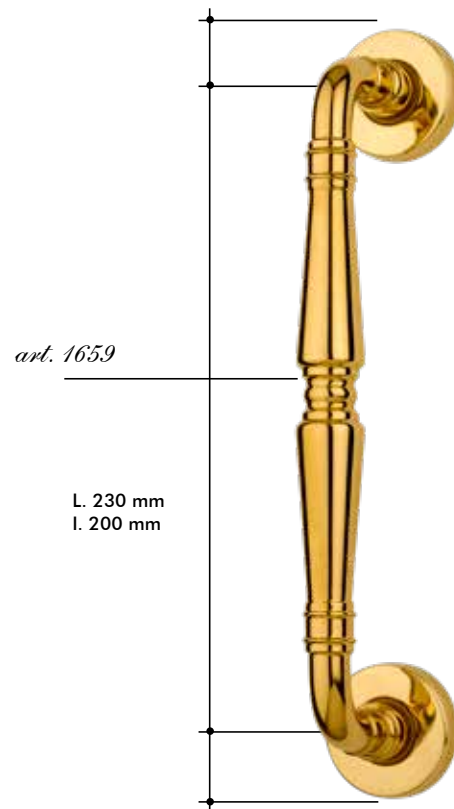
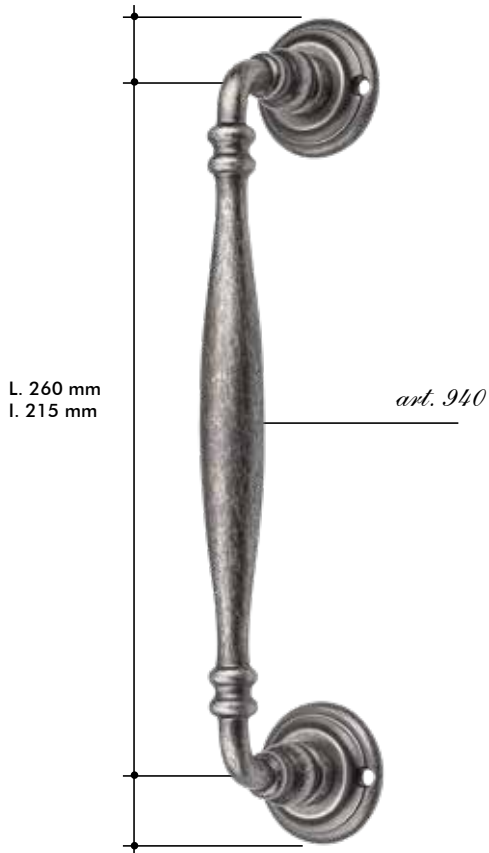
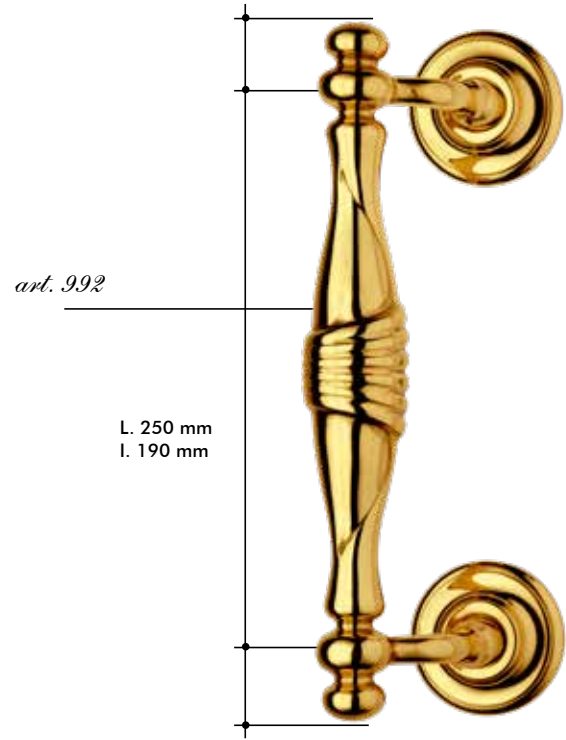
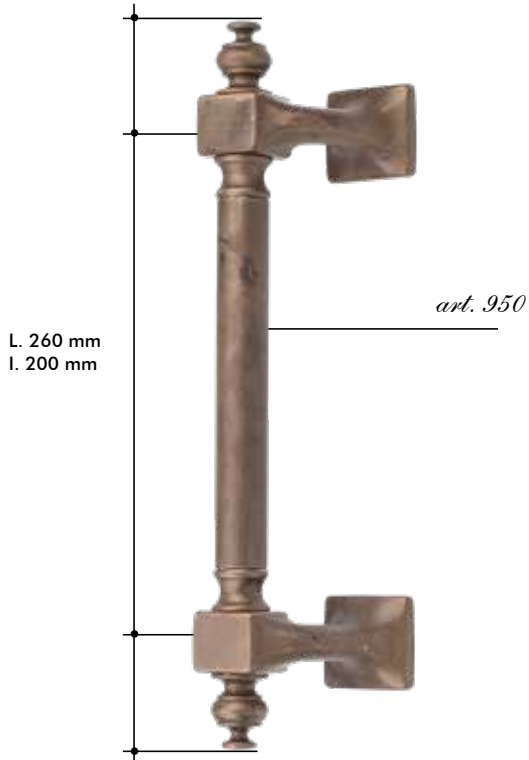

OLV



OLN



OVI



OIP



NA

(extra + 15%)



ORG

(extra + 25%)

Pomoli e Battenti



वता लन

ववददविलययागशव
नीदुश॥२२॥

समथगदा
शक्ति

मागन
सद
साथी
वदवा
मि
२१
२२
२३
२४
२५
२६
२७
२८
२९



art. 127 ø 70



art. 522 ø 115



art. 131 ø 70

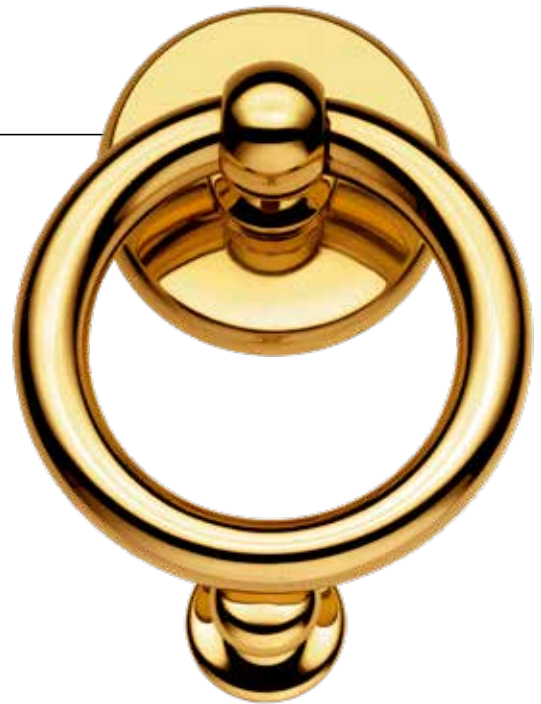

art. 520 ø 110



OLV



OLN



OVI



OIP



NA

(extra + 15%)



ORG

(extra + 25%)

Kit Scorrevoli e Minuteria





Misure:
60 mm.
80 mm.
100 mm.
120 mm.
140 mm.

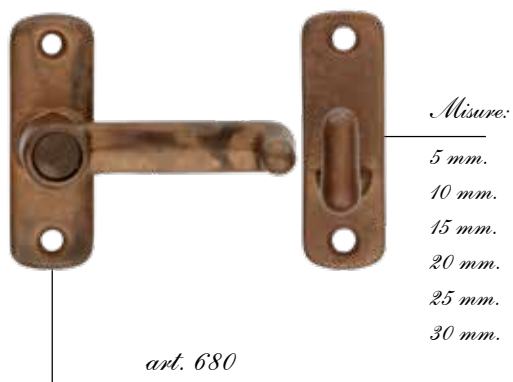
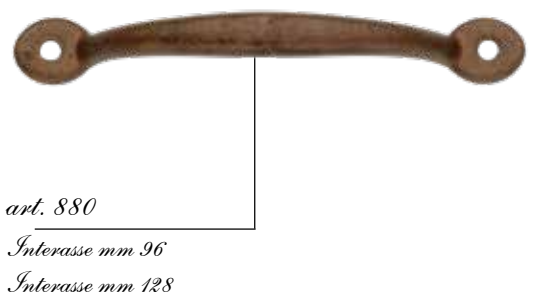

OLV



OLN



OVI



OIP



NA

(extra + 15%)



ORG

(extra + 25%)

Altri particolari



ॐ नमो भगवते वासुदेवाय
ॐ नमो भगवते वासुदेवाय

अथ वासुदेवि स्तोत्रम्
ॐ नमो भगवते वासुदेवाय



*art. 1840
alzante singolo*

*Disponibile versione a
coppia con foro yale
art. 1841*



art. 1909



*art. 1301
ovalino singolo
su rosetta, senza bocchetta*

Specificare se fisso o girevole

Misure diametro interno:

Ø 14 mm

Ø 16 mm

Ø 20 mm

*art. 21
Copricerniera*



OLV



OLN



OVI



OIP



NA

(extra + 15%)



ORG

(extra + 25%)

CONDIZIONI GENERALI DI VENDITA

PREZZI:

Il prezzo di listino è riferito a N° 1 pezzo dell'articolo con codice ad esso riferito IVA esclusa con resa franco partenza.

SPEDIZIONI:

La merce viaggia in ogni caso a rischio e pericolo del committente. In assenza di precise istruzioni circa il mezzo di inoltro della merce le spedizioni sono eseguite nel modo ritenuto più idoneo ed economico senza nessuna responsabilità della Casa.

PAGAMENTI:

Devono essere effettuati direttamente al domicilio della nostra sede o mediante spedizione di nostre ricevute bancarie entro la scadenza concordata. Eventuali ritardi comportano il conteggio degli interessi di mora.

ORDINI:

Tutti gli ordini devono essere inoltrati ai nostri agenti di zona utilizzando codici e descrizioni corrette di quanto richiesto. Eventuali ordini inviati direttamente alla nostra sede sono accettati solo se trasmessi a mezzo mail e complementi di codici e descrizioni corretti di quanto richiesto. Tutti gli ordini, in ogni caso, sono subordinati all'approvazione della Casa.

FATTURAZIONE:

Il minimo importo netto merce fatturabile è di € 150,00.

TERMINI DI CONSEGNA:

Il termine di consegna e di spedizione, anche se confermato, costituisce una semplice previsione ed ha perciò un valore indicativo, quindi non comporta nessuna garanzia e nessun indennizzo è dovuto per la mancata consegna nel termine previsto.

ARTICOLI E RICHIESTE FUORI CATALOGO:

Ogni variazione rispetto agli articoli a listino è da considerarsi prodotto speciale per il quale, di volta in volta, è necessario richiedere fattibilità, quantità minima, prezzo. La fornitura di prodotti speciali a richiesta è subordinata all'accettazione da parte del committente della relativa conferma d'ordine. La Casa si riserva il diritto di approvare modifiche agli articoli e variazione dei prezzi senza preavviso.

RESI:

Non si accettano resi di merce, se non espressamente autorizzati dalla Casa. Le contestazioni, devono essere fatte entro 8 giorni dal ricevimento della merce. Le richieste di reso devono pervenire a mezzo mail, verranno analizzate ed eventualmente autorizzate mediante apposita "**Scheda di Autorizzazione Reso**" indicante tutte le modalità e condizioni alle quali verrà accettato il reso. Qualsiasi reso pervenuto senza preavviso ed autorizzazione verrà respinto al mittente. Per prodotti speciali approntati a richiesta non si accettano resi per alcun motivo.

Per qualsiasi controversia è competente il Foro di Brescia.

CAMPIONATURA:

Materiale pubblicitario gratuito con un primo ordine superiore a € 1.000,00.

AVVERTENZE IMPORTANTI

L'**OTTONE** e la **ZAMA** sono leghe soggette all'ossidazione, vulnerabili all'azione del tempo e dell'usura, in relazione ai diversi tipi di finiture e all'intensità di utilizzo.

SI RACCOMANDA DI:

EVITARE

di installare il prodotto in ambienti freschi di pittura (attendere l'essiccazione completa di qualsiasi tipo di tinteggiatura, su muro o su legno), e nelle vicinanze di parquet in legno appena posati e verniciati, pavimenti in marmo e granito appena levigati.

EVITARE NEL MODO PIÙ ASSOLUTO

L'uso di sostanze corrosive quali detersivi, pulivetro, sidol, abrasivi e altri prodotti similari lucidanti o sgrassanti contenenti acido fluoridrico o muriatico.

La scalfittura ad opera di oggetti contundenti quali chiavi, anelli, cacciaviti, viti e altri.

SPOLVERARE O PULIRE IL PRODOTTO CON UN PANNO MORBIDO DI LANA O SE NECESSARIO CON SPUGNA E SEMPLICE ACQUA TIEPIDA.

IMBALLO - PACKAGING:

MANIGLIA	QUANTITÀ PER CARTONE
rosetta imballo singolo	18
rosetta imballo doppio	24
placca	24
dk imballo a 2 pezzi	36
dk imballo a 4 pezzi	48







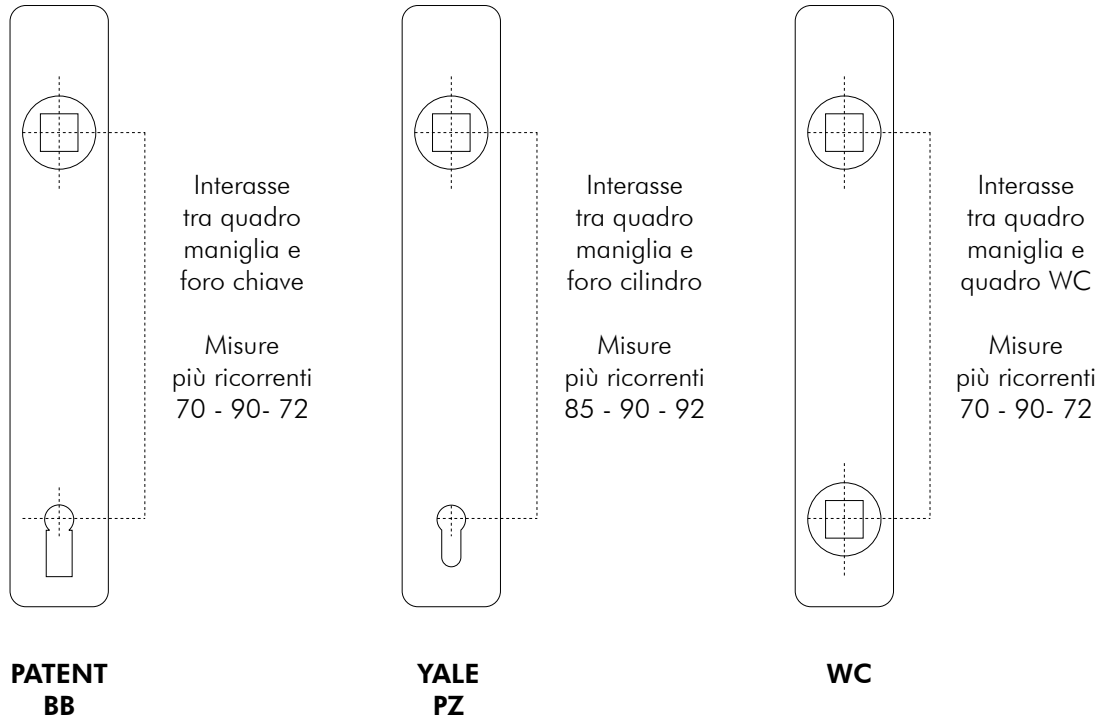

INDICAZIONI PER UNA CORRETTA STESURA DELLE COMMISSIONI

Per ogni ordinazione è necessario segnalare sulle commissioni i dati identificativi del modello desiderato, indicando il codice dell'articolo. È inoltre indispensabile precisare:

A) PER LE MANIGLIE SU PLACCA: il tipo di foro e la distanza (interasse) fra il foromaniglia e il foro chiave:



B) PER LE MANIGLIE DA FINESTRA: indicare se si richiede la guarnitura (senza meccanismo) che agisce esclusivamente in chiusura con il solo ferro Q.7 o LA GUARNITURA CON MECCANISMO, in questo caso è indispensabile specificare il tipo di meccanismo "gioco" da applicare:

	Gratz con fori		Gratz con fori $\varnothing 7$		MP per aste da incassare e ferro $\varnothing 7$
	Gratz con bussole		Gratz con bussole e ferro $\varnothing 7$		MP per aste da incassare
	Gratz con perni		Gratz con perni e ferro $\varnothing 7$		Gola lupo laterale

DENOMINAZIONE DEL VERSO "MANO" maniglie singole

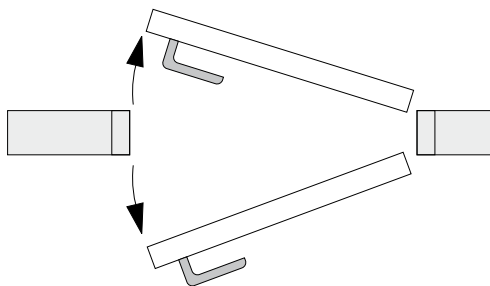
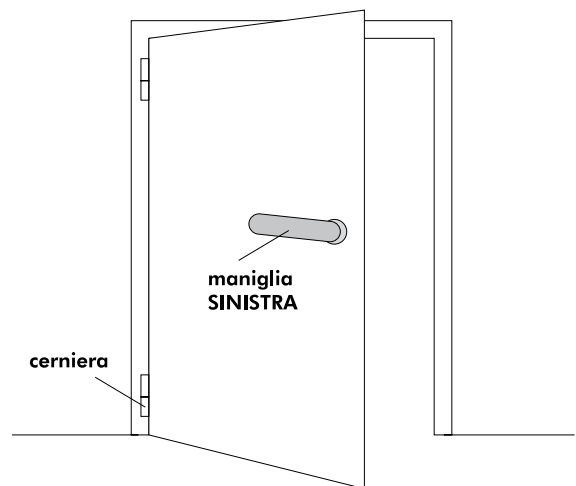
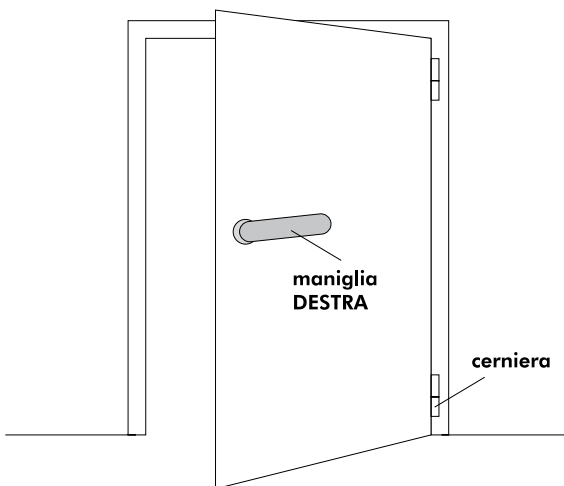

"mezza" maniglia DESTRA
sia per porte a tirare
che a spingere

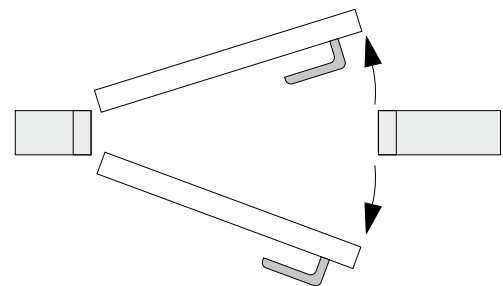

"mezza" maniglia SINISTRA
sia per porte a tirare
che a spingere

